WOO AUDIO WA7 Fireflies

2nd Generation Since March 15, 2016

Pure Class-A Single-ended Vacuum Tube Headphone Amplifier

&

24-Bit/384kHz Digital to Analog Converter



Owner's Manual

Please review this manual before operating your WOO AUDIO™ product.

Important Safety Information

FC CAN ICES-3(B)/NMB-3(B)



CAUTION: Amplifiers are shipped without the vacuum tubes installed. The end user must install the tubes, taking great care to install them correctly in the appropriate sockets. Incorrect installation will result in *serious damage* **not** covered by the *warranty*.



Turn off immediately in the event of malfunction!
Should you notice smoke or an unusual smell coming from the equipment, turn it off immediately. Continued operation could result in injury.



Do not disassemble
The unit contains high voltage circuitry. Touching the amplifier's internal parts may result in injury. In the event of malfunction, the product should be repaired only by a qualified technician.



Keep out of children
Failure to observe this precaution could result in injury



WARNING: Failure to follow these instructions could result in fire, electric shock, or other injury or damage.

Table of Contents

IMPORTANT SAFETY INFORMATION	2
TABLE OF CONTENTS	3
OVERVIEW	4
GETTING STARTED	7
QUICK INSTALLATION	10
OPERATIONS	13
FAQ - FREQUENTLY ASKED QUESTIONS	14
WARRANTY AND SERVICE	15
PRODUCT SPECIFICATION	16
REVIEWS	17

Overview

The multi award-winning WA7 Fireflies is improved and better than ever. Among the numerous enhancements is a newly designed ESS SABRE Reference DAC that is crucial to the WA7's sound quality. The new ESS DAC reveals the elusive – yet desired – dynamics and details in your digital audio files. The new XMOS xCORE-AUDIO asynchronous clocking USB controller is compatible with PC, Mac, Android and iOS devices. Other enhancements include improved analog circuitry, premium Teflon tube sockets, and USB connector.

The WOO Audio WA7 “Fireflies” Amp/DAC is a combination of high performance vacuum tube headphone amplifier with a built-in USB Digital-to-Analog Converter. It employs a pure tube design, utilizing 6C45 tubes in a class-A, single-ended topology, with transformer coupled outputs. No semi-conductors used in the entire signal path. The D-A converter is designed to be capable of up to 24-bit/384k sampling rates. Pure data integrity is maintained while it is transmitted via standard high speed USB 2.0 interface operating in asynchronous mode.

The high quality construction features include a pair of Nickel Alloy core output transformers, all-aluminum chassis with no screws visible from any viewing angles, a linear external power supply for amplification circuitries, a custom built toroidal power transformer, and multi-layer military grade PCBs.

The dedicated port for in-ear-monitors carries a full range of volume controls ensuring minimal noise. Despite its incredibly compact size, “Fireflies” is a power-house with the capacity to drive almost any demanding audiophile headphones. To accommodate different system setup needs, “Fireflies” can also be used as a stand-alone D-A Converter.

Identifying the 2nd Generation Fireflies:



Features:

- Handmade output transformer with Nickel Alloy core
- 24-Bit, 384kHz high resolution playback
- Ultra-low jitter USB 2.0 runs on Asynchronous mode
- High and low impedance output facilitated via toggle switch on back panel
- Open load protection will automatically engage to prevent the amp from damaging when no headphones are plugged in
- Multi-functional switch for USB input, RCA input, and RCA output via D/A.
- The RCA connectors can be used either as RCA analog inputs or USB DAC preamp outputs
- All-aluminum chassis with no screws visible from any viewing angles
- High clarity tube protection glass
- Multi-layer military grade PCBs
- Customized driver for Windows Vista/XP/7/8
- USB Audio Class 2.0 is natively supported by Apple OS X version 10.6.4 and above without installing driver

Getting Started

What's in the box?

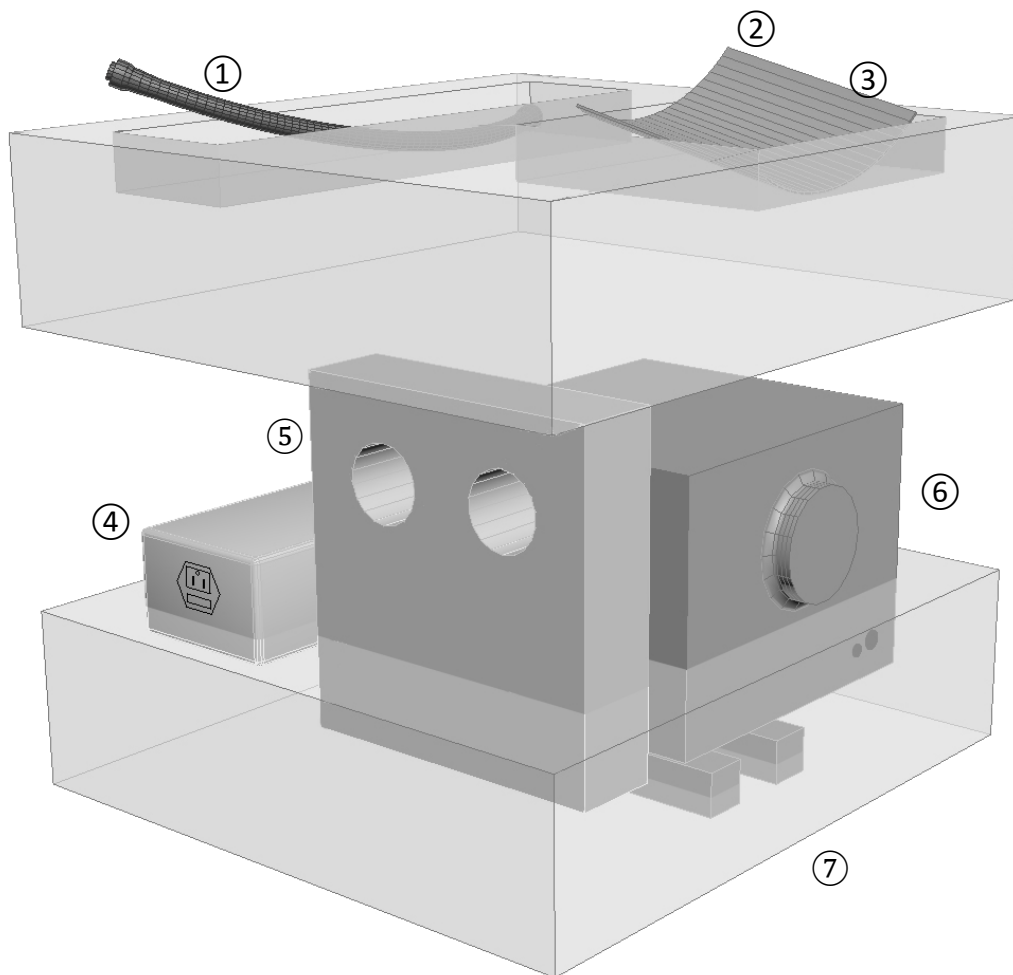

- ① Umbilical DC Power Cord
- ② Micro-fiber Polishing Cloth for glass and metal cleaning
- ③ Anti-slip silicone rubber glass pads (4pcs)
- ④ External Power Supply
- ⑤ Tube Protection Glass
- ⑥ WA7 Fireflies Amplifier
- ⑦ 6C45 Matched Pair Tubes

*** USB, AC power cord,
and inter-connection
cables are not included.**

Front Panel



- ⑦ Volume control for headphone outputs
- ⑧ 3.5mm or 1/8" mini In-Ear-Monitors headphone jack
- ⑨ 6.35mm or 1/4" headphone jack

Top Panel

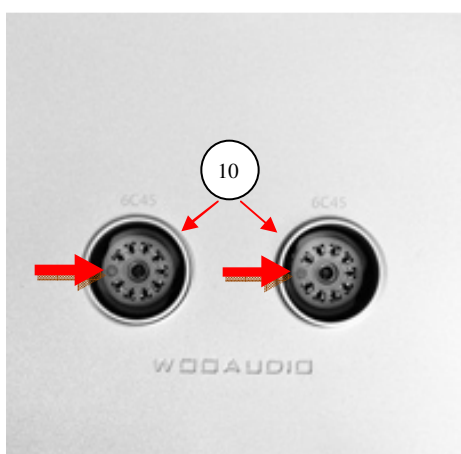

- ⑩ Tube sockets for 6C45 vacuum tubes



Please pay close attention to vacuum tube installation alignment marks!

Back Panel

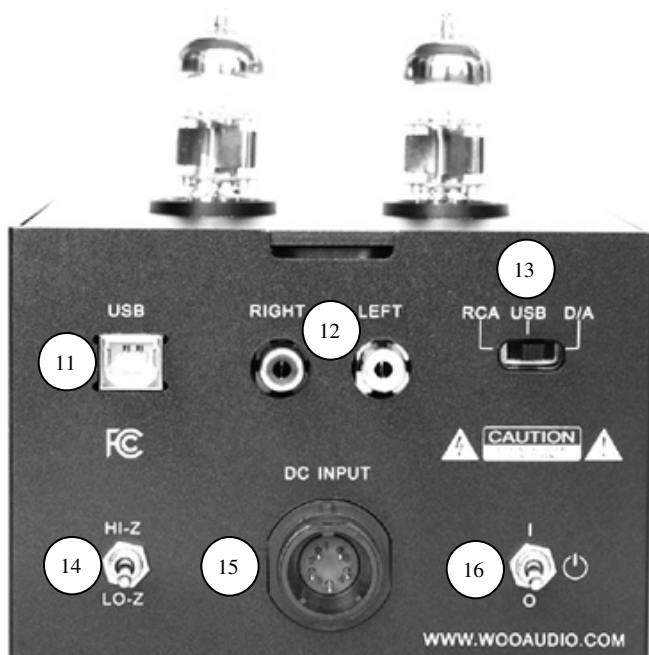

- ⑪ USB 2.0 digital input
- ⑫ RCA analog input
- ⑬ Input-output switch
 - RCA – RCA analog input
 - USB – USB 2.0 digital input
 - D/A – Digital to Analog output via RCA
- ⑭ High and low headphone impedance switch
 - HI-Z – High impedance
 - LO-Z – Low impedance
- ⑮ Umbilical power cord socket (male)
- ⑯ Power switch
 - I – ON
 - O – OFF



The RCA connectors can be used either as RCA analog inputs or USB DAC RCA line-out outputs.

External Power Supply DC power connection



- ① Umbilical cord socket (female)
- ② Power LED light

External Power Supply AC power connection

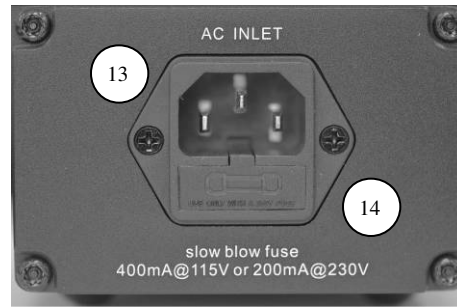

- ① AC power inlet
- ② Fuse box
slow blow fuse, 400mA@115V or
200mA@230V

Connections

The WA7 Firflies can be connected in one of the following ways.

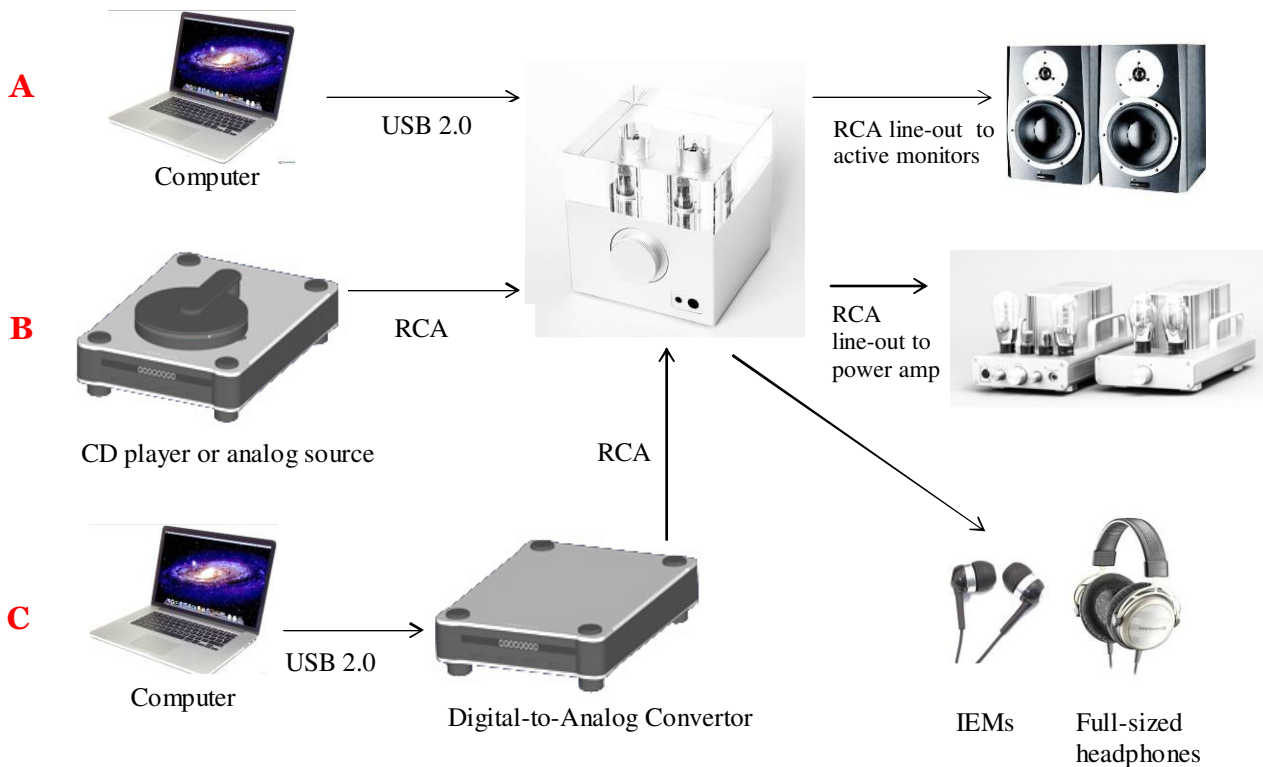

Quick Installation

Installing tubes

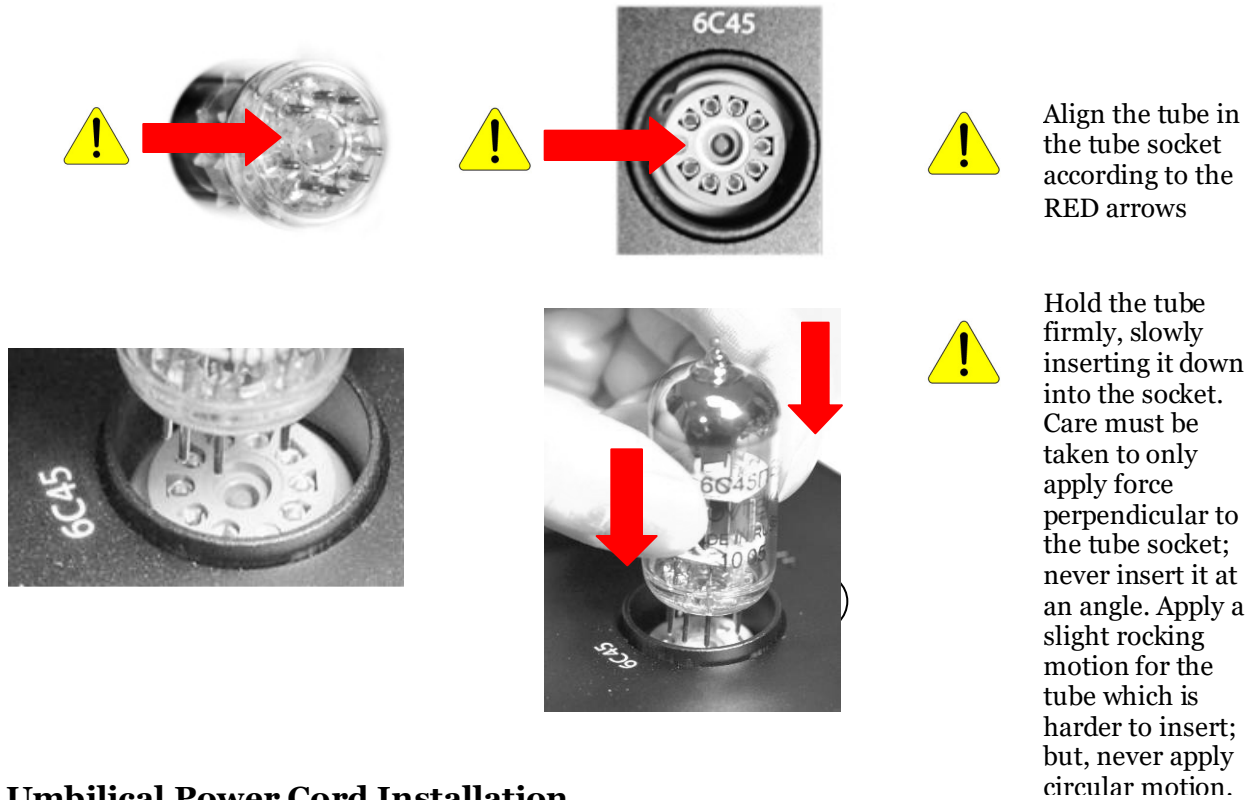

Umbilical Power Cord Installation

Connecting the Amplifier unit

Align the female plug to the DC input connector. The “arrow” marking on the plug should face up when it is properly oriented. Insert the plug into the socket and turn the locking ring on the plug until fully tightened.

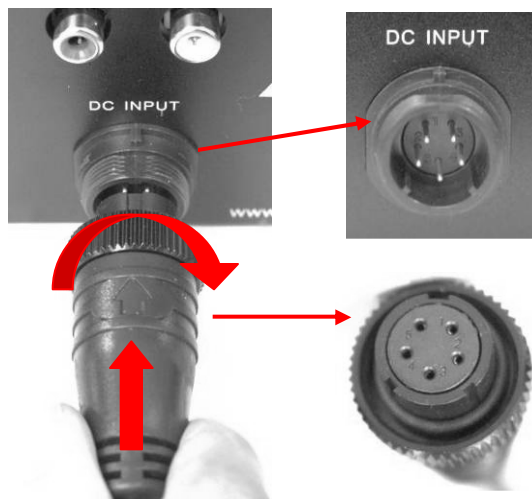

Connecting the Power Supply unit

Align the male plug to the DC input connector. The arrow marking on the plug should face up when it is properly oriented. Insert the plug into the socket and turn the locking ring on the plug until fully tightened.

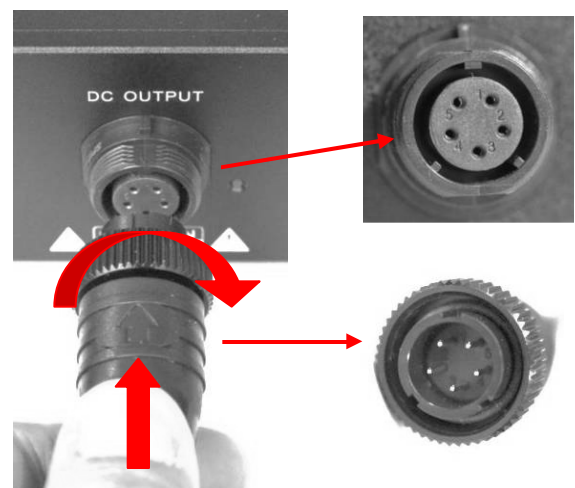

Installing the AC power cord (customer supplied):

Plug the power cord into the AC inlet; see ⑬ in the above diagram. The AC inlet socket is a standard IEC type. You will need to obtain the correct type for your region if it not supplied with your order.



U.S.



European



U.K.

Installing Tube Protection Glass:



Do not hit the tubes by the glass. The glass is heavy. Handle with both hands.



Powering Up

To power up on the WA7 Fireflies, flip the power switch ⑯ to the “I” position. The LED on the power supply will lit. Vacuum tubes should lit at the same time.

Using the Asynchronous USB 2.0 port:

The WA7 Fireflies offers a USB 2.0 port ⑪, refer to the above diagram, which is compatible with Windows or Mac OS computer.

Installing the USB driver

*These steps only apply for Windows 7/8/10.

1. Plug in the USB 2.0 cable to the WA7 Fireflies and your computer.
2. Install the WA7 Fireflies Driver from the downloaded file from <http://www.woaudio.com/drivers/WA7.1-driver-for-Windows.exe>
3. Unzip the downloaded file. Locate setup.exe file and run it.
4. Follow on-screen instruction to complete the installation. Windows restart may be required.
5. Set USB Speakers as your default audio output.

Go to My Computer -> Control Panel -> Hardware and Sounds -> Sounds
-> Click XMOS USB Speakers -> Click Set Default

6. Now you're ready to enjoy music from your computer.

Configuring media player

TIPS: It is strongly recommended to use a media player that supports ASIO output mode for the highest playback quality.

Changing Output mode

Example is given for JRiver Media Center.

Tools -> Options -> Audio Output -> Output mode -> select **XMOS USB Audio 2.0 ST 3066 [ASIO]**

Operations

NOTE: Only one headphone output is operational at a time. When both headphone jacks are plugged in, only the 1/4" output is operational.

DO NOT

- Turn on the amp before properly installing **ALL** tubes and power supply.
- Block vent holes of the power supply.
- Use tubes that are not approved by Woo Audio.
- Align the male plug to the DC input connector. The arrow marking on the plug should face up when it is properly oriented. Insert the plug into the socket and turn the locking ring on the plug until fully tightened.
- Remove any tubes or the umbilical power cord while the amp is operating.
- Touch tubes (**they are extremely hot**) after warm-up.
- Leave the amp running unattended. (We suggest a maximum of 8 hours of continuous use, allowing the tubes time to cool before using again)
- Place amplifier in direct sunlight. Extended exposure may cause discoloration to the anodize aluminum.

DO

- Place the amp away from any wireless or frequency-emitting devices such as mobile phones, PDAs and radios, to avoid noise interference.
- Keep away from water or excessive moisture.
- Turn off the amp if its sound is abnormal.
- Allow a minimum of 2 inches of air clearance for heat dissipation.
- Allow approximately 3 minutes of warm-up.
- Allow the tubes to cool down before replacing them.

FAQ - Frequently Asked Questions

Computer cannot find the WA7 Fireflies USB DAC.

- Check USB cable connection and make sure the cable is USB 2.0 compatible.
- See “Installing USB driver” section for configuration.

No sound is coming out of the headphone jack.

- Check you have selected the correct position of the Input-Output switch. Check input connection. Check computer USB output setting if USB input is used.

No sound is coming out of the mini headphone jack.

- Only one headphone is operational at a time. Disconnect headphones from the ¼” jack to enable output of the mini phone jack.

There is static noise, or one channel is dropping out.

- Re-seat all tubes. Make sure that all tubes are securely installed.

The LED does not light.

First check if the AC cord is installed. Next, check if the umbilical cord is securely attached between the amp and the power supply. If the fuse is burnt, see the following instruction on how to replace a fuse. The fuse type is 400mA@115V or 200mA@230V, slow blow type.



Insert a small flat screwdriver into the fuse door located on the AC inlet.

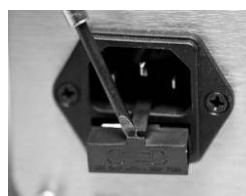

Pull the fuse door to open it.



The fuse holder may be released from the AC inlet.



Replace the burnt fuse with a new one

Warranty and Service

Woo Audio warrants this product free from defects in materials and workmanship for one (1) year from the original date of purchase. The tubes are warranted for 30 days unless otherwise stated. In the event that your Woo Audio product requires servicing, please contact us directly to receive return instructions. Please do not discard original packing materials. If for any reason, the equipment is to be shipped back to Woo Audio, please use the original packaging, including a copy of sales purchase documents and a detailed explanation of the problem(s).

Send service inquiry to info@woaudio.com

Any modification not authorized by WOO AUDIO will void this warranty.

Product Specification

Model:	WA7 Fireflies
Headphone amp design	Single-ended, class-A, transformers output
Power supply	Linear external power supply. Tube power supply optional
Tubes used	One matched pair of 6C45, one tube per channel
USB receiving chipset:	XMOS xCORE-AUDIO
DAC chip	ESS SABRE ES9018K2M Reference DAC
Sampling Rate:	Up to 24-Bit, 384kHz
Inputs:	1 Asynchronous USB2.0, 1 RCA
Outputs:	1 1/4" and 1 1/8" headphone outputs, 1 RCA (same connector as the input)
Headphones impedance	8-600 Ohms
RCA input impedance	100 Kilo-Ohms
Max Output:	Approx. 1 watt @ 32 ohms
Frequency response:	11Hz to 27kHz, +/-0.5dB
Distortion:	<0.03%
S/N:	95dB
Power consumption	25W max
Mains Supply:	100-120V, 220-240V, 50/60Hz, user selectable
Fuse	slow blow fuse, 400mA@115V, or 200mA@230V
Amp body and PSU finish	Anodized Aluminum
Dimension:	AMP: 4.8" L x 4.8" W x 5.1" H with glass PSU: 7" L x 3.5" W x 2.2" H
Weight:	AMP - 5.3 lbs / 2.4kg, Glass - 3.3 lbs / 1.5 kg PSU - 2.8 lbs / 1.4 kg

Reviews

The WA7 is one of the few home headphone amps that sounds great with full-size and in-ear headphones. - Audiophiliac

*This is possibly the most linear DAC and headphone amp I've heard.
-Positive Feedback*

The Woo reaches DEEP, and is POWERFUL. It's everything you want it to be and just a tad more ... because it's so damn sexy you feel like you stole it from the future somehow. -Humanovation

Appreciable about the WA7 was that whatever headphones or IEMs I used with it, the performance was consistent. -Currawong @ head-fi.org

the WA7 is practically a steal in terms of sound quality and physical presentation. - HP Soundings

**Woo Audio is committed to continuously improve its products.
We therefore reserve the right to improve on our design without notice.**