

Digital Music Player
NW-WM1A/WM1Z



Use this manual when you have trouble or when you need to know how to use your WALKMAN®.

The color of Walkman sold in some countries/regions may differ from those shown above.

The contents of the Help Guide may be subject to change without notice due to updates to the product's specifications.

[Getting Started](#)

[Customer registration websites](#)

[Before first use](#)

[Walkman manuals and general information](#)

[Checking the contents of the package](#)

[Using the supplied accessories](#)

[Using a leather case](#)



Configuring the initial setup

Installing Media Go (Windows)

Installing Content Transfer (Mac)

Power/Charging

Turning the Walkman on or off

Using the HOLD switch

Charging the battery

Extending the battery life

Notes on charging the battery

microSD Cards

Using a microSD card

Notes on microSD cards

Basic Operations

Parts and controls

Screen operations

How to use the various screens on the Walkman

Library screen

Playback screen

Lineup screen

Bookmark List screen

Sound quality setting screens

List of icons displayed in the information area

Adjusting the volume

Browsing the operating guide

Transferring Music

Preparing music content

Purchasing High-Resolution Audio content

Using a Windows computer

Transferring content from a Windows computer using Media Go



Transferring content using Windows Explorer



Importing content from the Walkman to Media Go



Using a Mac computer

Transferring content from a Mac computer using Content Transfer



Transferring content using Mac Finder



Adding lyrics information using a computer

Notes on transferring content from a computer

Playing/Organizing/Deleting Music

Playing music

Playback methods

Using [SensMe™ Channels]

Displaying lyrics

Obtaining lyrics information



Displaying lyrics



Managing playlists on the Walkman

Managing bookmarks on the Walkman

Deleting tracks from the Walkman

Viewing a guide to enjoy high quality sound

Various Functions

Bluetooth

Connecting the Walkman to an unpaired Bluetooth device for the first time



Connecting the Walkman to a paired Bluetooth device



Establishing a Bluetooth connection using NFC



Configuring the Bluetooth function



Notes on the Bluetooth function



Adjusting the sound quality settings

Using USB Mass Storage mode

Restarting / Reformatting / Initializing

Restarting the Walkman

Resetting/Reformatting/Initializing the Walkman

Formatting a microSD card

Version information/System updates

Checking information on the Walkman

Updating the Walkman system software

Using shortcut buttons from the quick setting panel

Settings menu

Announcement

Notes on handling the Walkman

Notes on the headphones

Notes on the built-in battery

Notes on the software

General Information

Maintenance

Customer support website

Specifications

Specifications

Battery life

Maximum recordable number of songs

Supported formats

System requirements

Troubleshooting

Power/Charging

The built-in rechargeable battery becomes depleted quickly even after the Walkman is fully charged.

What is the battery lifespan?

Can I replace the built-in rechargeable battery myself?

microSD Cards

The computer does not recognize the microSD card in the Walkman.



The Walkman does not recognize a microSD card.



Media Go

Media Go cannot be installed on a computer. Installation of Media Go fails.



Media Go does not recognize the Walkman.



Playing Music

The Walkman cannot play transferred content.



A track is duplicated on the Walkman.



Others

You have spilled liquid (water, coffee, etc.) on the Walkman.

You have washed the Walkman in a washing machine.



The Walkman does not work properly.



Table Of Contents

NW-WM1A/WM1Z Help Guide.....	i
Getting Started.....	i
Customer registration websites.....	1
Before first use.....	2
Walkman manuals and general information.....	4
Checking the contents of the package.....	6
Using the supplied accessories.....	i
Using a leather case.....	7
Configuring the initial setup.....	9
Installing Media Go (Windows).....	10
Installing Content Transfer (Mac).....	12
Power/Charging.....	ii
Turning the Walkman on or off.....	13
Using the HOLD switch.....	14
Charging the battery.....	16
Extending the battery life.....	18
Notes on charging the battery.....	19
Using a microSD card.....	21
Notes on microSD cards.....	23
Parts and controls.....	24
Screen operations.....	ii
How to use the various screens on the Walkman.....	27
Library screen.....	30
Playback screen.....	32
Lineup screen.....	34
Bookmark List screen.....	36
Sound quality setting screens.....	38
List of icons displayed in the information area.....	40
Adjusting the volume.....	42
Browsing the operating guide.....	44
Preparing music content.....	45
Purchasing High-Resolution Audio content.....	49
Using a Windows computer.....	ii
Transferring content from a Windows computer using Media Go.....	51
Transferring content using Windows Explorer.....	55
Importing content from the Walkman to Media Go.....	57
Using a Mac computer.....	iii
Transferring content from a Mac computer using Content Transfer.....	60

Transferring content using Mac Finder.....	62
Adding lyrics information using a computer.....	64
Notes on transferring content from a computer.....	67
Playing music.....	68
Playback methods.....	70
Using [SensMe™ Channels].....	72
Displaying lyrics.....	iii
Obtaining lyrics information.....	73
Displaying lyrics.....	74
Managing playlists on the Walkman.....	75
Managing bookmarks on the Walkman.....	77
Deleting tracks from the Walkman.....	79
Viewing a guide to enjoy high quality sound.....	80
Various Functions.....	iii
Bluetooth.....	iii
Connecting the Walkman to an unpaired Bluetooth device for the first time.....	81
Connecting the Walkman to a paired Bluetooth device.....	84
Establishing a Bluetooth connection using NFC.....	86
Configuring the Bluetooth function.....	88
Notes on the Bluetooth function.....	89
Adjusting the sound quality settings.....	90
Using USB Mass Storage mode.....	92
Restarting / Reformatting / Initializing.....	iii
Restarting the Walkman.....	94
Resetting/Reformatting/Initializing the Walkman.....	95
Formatting a microSD card.....	97
Version information/System updates.....	iv
Checking information on the Walkman.....	98
Updating the Walkman system software.....	99
Using shortcut buttons from the quick setting panel.....	101
Settings menu.....	103
Notes on handling the Walkman.....	106
Notes on the headphones.....	108
Notes on the built-in battery.....	109
Notes on the software.....	110
General Information.....	111
Maintenance.....	112
Customer support website.....	113
Specifications.....	115
Battery life.....	118

Maximum recordable number of songs.....	119
Supported formats.....	120
Troubleshooting.....	iv
System requirements.....	122
Power/Charging.....	iv
The built-in rechargeable battery becomes depleted quickly even after the Walkman is fully charged.....	124
What is the battery lifespan?.....	125
Can I replace the built-in rechargeable battery myself?.....	126
microSD Cards.....	iv
The computer does not recognize the microSD card in the Walkman.....	127
The Walkman does not recognize a microSD card.....	128
Media Go.....	v
Media Go cannot be installed on a computer. Installation of Media Go fails.....	129
Media Go does not recognize the Walkman.....	130
Playing Music.....	v
The Walkman cannot play transferred content.....	132
A track is duplicated on the Walkman.....	133
Others.....	v
You have spilled liquid (water, coffee, etc.) on the Walkman.You have washed the Walkman in a washing machine.....	135
The Walkman does not work properly.....	136

Digital Music Player
NW-WM1A/WM1Z

Customer registration websites

We recommend that you register the Walkman to get better customer support.

For customers in the US:

<http://www.sony.com/walkmanreg/>

For customers in Canada:

English

<http://www.Sony.ca/Registration>

French

<http://www.Sony.ca/Enregistrement>

For customers in Latin America:

<http://www.sony-latin.com/registration>

For customers in Europe:

www.sony.eu/mysony

For customers in Asia/Oceania/the Middle East/Africa:

English/Korean/Traditional Chinese

<http://www.sony-asia.com/dmpwalkman/register/>

Simplified Chinese

https://www.sonystyle.com.cn/b2c_sony/b2c/productRegister.do

The contents of the Help Guide may be subject to change without notice due to updates to the product's specifications.

Digital Music Player
NW-WM1A/WM1Z

Before first use

Thank you for purchasing a Walkman.

- For information on laws, regulations and trademark rights, refer to “Important Information” contained in the supplied software. To read it, install the supplied software on your computer.
- Before you start using the Walkman, read the topics under [Related Topic].
- All other trademarks and registered trademarks are trademarks or registered trademarks of their respective holders. In this manual, TM and ® marks are not specified.

Before you start using the Walkman, check the following information.

Model names

Several model names appear in this [Help Guide]. Some models are not available depending on the country or region where you purchased the Walkman.

Computer system requirements

When you connect the Walkman to a computer, check the computer system requirements.

Battery charging

The battery might be low when you use the Walkman for the first time. Charge the battery before use.

microSD cards

The following memory cards are referred to as [microSD cards] in this [Help Guide].

- microSD cards
- microSDHC cards
- microSDXC cards

Images and illustrations

The screen images and illustrations shown in this [Help Guide] are for reference only. They may differ from the actual product or onscreen display.

Design and specifications are subject to change without notice.

Related Topic

- [Walkman manuals and general information](#)
- [System requirements](#)
- [Charging the battery](#)
- [Notes on handling the Walkman](#)
- [Notes on the headphones](#)
- [Notes on the built-in battery](#)
- [Notes on the software](#)
- [General Information](#)
- [Maintenance](#)
- [Customer support website](#)

Digital Music Player
NW-WM1A/WM1Z

Walkman manuals and general information

Sony provides the following manuals and information regarding the Walkman.
The provided manuals explain the following operations and functions.

- Basic operations.
- Unique functions that require explanations.
- Complicated operations that require instructions.

Help Guide

This Help Guide provides the standard operating procedures only.

- How to transfer content to the Walkman.
- How to use various functions.
- Notes on using the Walkman.

Startup Guide (printed)

- Basic steps to start listening to music after you purchase the Walkman.

Instruction Manual (printed)

- Notes on using the Walkman
- Compliance information
- How to access [Important Information]

Important Information (supplied with the Walkman memory)

- Information on copyrights, laws, and regulations
To read the file, install the supplied software on your computer.

Customer support website (online)

See [Customer support website] in this [Help Guide].

- The latest information on the Walkman
- FAQ: Frequently Asked Questions

Related Topic

- [Customer support website](#)

4-593-855-11(1) Copyright 2016 Sony Corporation

Digital Music Player
NW-WM1A/WM1Z

Checking the contents of the package

NW-WM1Z/WM1A (Common)

- Walkman (1)
- USB cable (1)
- Wrist strap (1)
- Startup Guide
- Instruction Manual

NW-WM1Z

- Leather case (1)

Note

- Headphones and a microSD card are not supplied with the Walkman.

The contents of the Help Guide may be subject to change without notice due to updates to the product's specifications.

Digital Music Player
NW-WM1A/WM1Z

Using a leather case

(Only for models supplied with a leather case)

To attach the leather case

Place the Walkman inside the leather case.

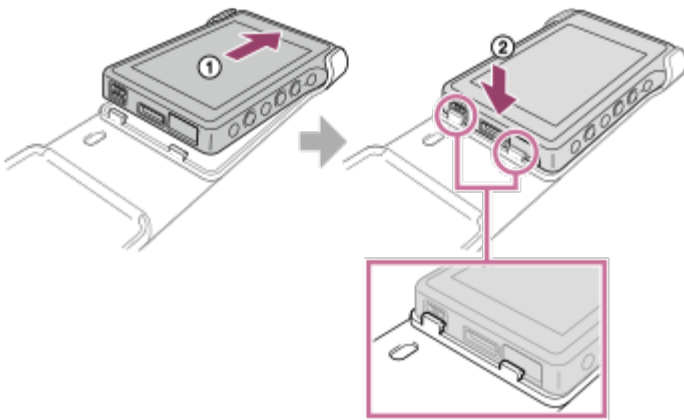

Attach the projecting parts of the leather case to the slots on the Walkman.

To remove the Walkman from the leather case

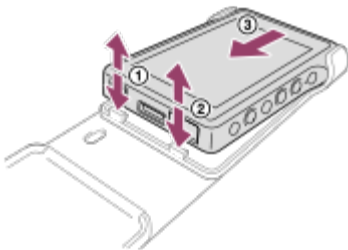

Notes on the genuine leather case

- The leather case is made of natural leather. Unlike artificial leather, natural leather may have scratches, wrinkles, or vein marks on the surface. Each leather case has different characteristics and colors.
- Leather is a soft material. If you wrap the headphone cord around the leather case, it may leave dents or cord marks on the leather case.
- Before you use a cleaner, read the instructions carefully. Try the cleaner on an inconspicuous part first.
- For cleaning, do not use any type of solvent such as alcohol or paint thinner. Such solvents may damage the leather case. For example, they may cause color fading, deformation, or degradation.
- Moisture such as rain or sweat, or friction may cause discoloration or color transference to your clothes, etc.
- Do not use or store the leather case in the following kinds of places.
 - Places where the leather case is exposed to direct sunlight (such as in a car).
 - Places with extremely high/low temperatures.

- Places with high humidity or dust.

The contents of the Help Guide may be subject to change without notice due to updates to the product's specifications.

Related Topic

- [Checking the contents of the package](#)

4-593-855-11(1) Copyright 2016 Sony Corporation

Digital Music Player
NW-WM1A/WM1Z

Configuring the initial setup

When you turn on the Walkman for the first time, the initial setup wizard will launch. You can set the following items during the initial setup.

- Language
- Date and time

1 Hold down the button (1) for 3 seconds until the Walkman turns on.

The initial setup wizard will launch. Confirm the message and tap .

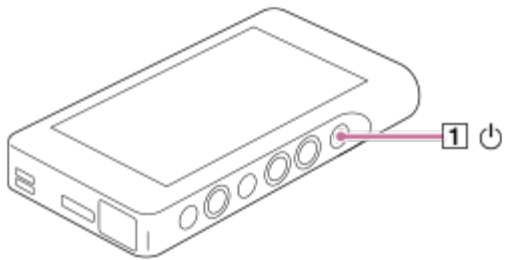

2 Select the language and tap .

3 Set date and time, and then tap .

Follow the onscreen instructions.

You can view the [Guide to High Quality Sound] screen, if you prefer.

The contents of the Help Guide may be subject to change without notice due to updates to the product's specifications.

Digital Music Player
NW-WM1A/WM1Z

Installing Media Go (Windows)

Media Go is software for Windows computers. Use the latest version of Media Go. You can use Media Go to perform the following operations.

- Importing content (such as music) from CDs or online services to a computer.
- Organizing and managing the content.
For example, you can create playlists.
- Transferring content on a computer to the Walkman.
You can also transfer iTunes content to the Walkman via Media Go.

Confirm the system requirements before you install Media Go.

1 Access the Media Go download website.

<http://mediago.sony.com/>

2 Install Media Go.

Click  to install the software. Then, follow the onscreen instructions. When you finish the installation, Media Go will start automatically.

Hint

- Once you install Media Go, the latest version of Media Go will be downloaded automatically. (Only when the computer is connected to the Internet.) If an installation dialog appears, follow the onscreen instructions to install the software.
- The installer may be downloaded automatically to the download folder on some web browsers.

Note

- Restart the computer if you are prompted. Follow the onscreen instructions.

The contents of the Help Guide may be subject to change without notice due to updates to the product's specifications.

Related Topic

- [Preparing music content](#)
- [Transferring content from a Windows computer using Media Go](#)
- [System requirements](#)

4-593-855-11(1) Copyright 2016 Sony Corporation

Digital Music Player
NW-WM1A/WM1Z

Installing Content Transfer (Mac)

Content Transfer is software for Mac computers. Use the latest version of Content Transfer. You can transfer content that you manage with iTunes or Finder. You can simply drag-and-drop the tracks or albums to transfer them to the Walkman. Confirm the system requirements before you install Content Transfer.

1 Access the installer for Content Transfer for Mac.

<http://www.sony.net/ct-mac/>

2 Open the downloaded file.

[ContentTransfer.dmg] will be saved automatically to the download folder. The folder may open automatically.

3 Install Content Transfer.

Run [ContentTransfer.pkg]. Follow the onscreen instructions. When you finish the installation,  will be displayed.

Note

- Restart the computer if you are prompted. Follow the onscreen instructions.

The contents of the Help Guide may be subject to change without notice due to updates to the product's specifications.

Related Topic

- [Preparing music content](#)
- [Transferring content from a Mac computer using Content Transfer](#)
- [System requirements](#)

Digital Music Player
NW-WM1A/WM1Z

Turning the Walkman on or off

1 Hold down the button (1) for 3 seconds until the Walkman turns on.

When you turn on the Walkman for the first time, the initial setup wizard will launch. Follow the onscreen instructions. You can set the following items during the initial setup.

- Language
- Date and time

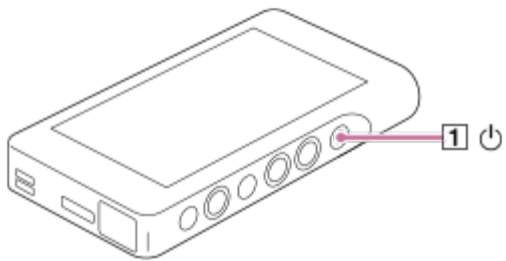

To turn off the Walkman

Hold down the button (1) for 3 seconds while the screen is turned on. Follow the onscreen instructions to turn off the Walkman. Release the HOLD function if it is turned on.

Hint

- The screen will turn off automatically if you do not operate the Walkman for a certain period of time. To turn on the screen, press the button (1).

The contents of the Help Guide may be subject to change without notice due to updates to the product's specifications.

Related Topic

- [Using the HOLD switch](#)
- [Configuring the initial setup](#)

Digital Music Player
NW-WM1A/WM1Z

Using the HOLD switch

You can lock the Walkman to prevent accidental button operation.

1 Slide the switch (1).

The HOLD function is enabled. You cannot operate the buttons on the Walkman or the touch screen. Only the button (2) is active and you can use it to perform the following operations.

- Turning the screen on or off.
- Turning on the Walkman (3 seconds).
- Restarting the Walkman (8 seconds).

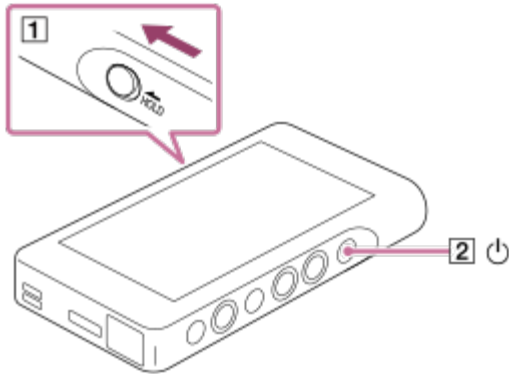

To enable the screen operation

You can enable the touch-screen operation while the HOLD function is active.

1. Tap the menu items in the following order.
☰ – [Settings] – [Device Settings] ([Basic Settings]).
2. Tap [Disable touch panel when the HOLD switch is on] to remove a check mark.
If you want to prevent accidental touch-screen operations, add a check mark again.

Hint

- Slide the switch (1) in the opposite direction of the arrow to release the HOLD function.
- While the HOLD function is active, **HOLD** will flash when you operate a button.
- When the HOLD function is enabled, you cannot turn off the Walkman. Release the HOLD function.

The contents of the Help Guide may be subject to change without notice due to updates to the product's specifications.

Related Topic

- [Parts and controls](#)

4-593-855-11(1) Copyright 2016 Sony Corporation

Digital Music Player
NW-WM1A/WM1Z

Charging the battery

1 Connect the Walkman to a running computer via USB.

The charge lamp will light up.

When charging is complete, the battery status icon switches to **FULL**.

Then, the charge lamp turns off.

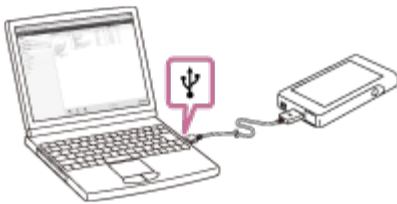

2 Disconnect the Walkman from the computer.

Hint

- For details on how long it takes to charge the battery fully, see [Specifications].

Note

- If the Walkman battery level is not sufficient, the computer will not recognize the Walkman. The Walkman screen will not turn on in this case. If this happens, charge the battery fully. It may take about 10 minutes before the Walkman screen turns on.

The contents of the Help Guide may be subject to change without notice due to updates to the product's specifications.

Related Topic

- [Extending the battery life](#)
-

Notes on charging the battery

- Specifications

4-593-855-11(1) Copyright 2016 Sony Corporation

Digital Music Player
NW-WM1A/WM1Z

Extending the battery life

You can reduce the battery consumption by using the Walkman in the following manner.
The battery life depends on usage conditions. For details on the battery life, see [Battery life].

- Turn off the power manually when you do not use the Walkman.
- Set a shorter time for [Screen Off Timer].
( – [Settings] – [Device Settings] ([Basic Settings]) – [Screen Off Timer].)
- Adjust the screen brightness.
- Set all sound quality settings to off.
- Disconnect the Bluetooth device when you are not using it.
- Turn off the NFC function when you are not using it.

The contents of the Help Guide may be subject to change without notice due to updates to the product's specifications.

Related Topic

- [Charging the battery](#)
- [Turning the Walkman on or off](#)
- [Settings menu](#)
- [Sound quality setting screens](#)
- [Establishing a Bluetooth connection using NFC](#)
- [Using shortcut buttons from the quick setting panel](#)
- [Notes on the built-in battery](#)
- [Displaying lyrics](#)
- [Battery life](#)

Digital Music Player
NW-WM1A/WM1Z

Notes on charging the battery

- The charging time depends on the battery usage conditions.
- When the battery is sufficiently charged but the battery life has dropped to about half of its normal span, the battery may be worn out. Contact the nearest Sony dealer or Sony Service Center.
- The computer may not recognize the Walkman in the following situations.
 - When you connect the Walkman to the computer for the first time.
 - When the Walkman has not been used for a long period of time.
Charge the Walkman for about 10 minutes. The Walkman may start operating normally.
- When the ambient temperature exceeds the recommended range,  appears on the screen and then charging is forcibly terminated. Charge the battery at an ambient temperature from 5 °C to 35 °C (41 °F to 95 °F).
- The battery can be recharged about 500 times from a completely depleted state. The exact number of times may vary depending on the usage conditions.
- To prevent deterioration of the battery, charge the battery at least once every 6 months.
- Charging is not guaranteed when you use a homebuilt or modified computer.
- Charging from a USB hub is only guaranteed when you use a self-powered USB hub that carries an authorized logo.
- Do not connect the Walkman to a computer for a long period of time when the computer is not connected to an AC power supply. Otherwise, the computer's battery may run out.
- While the Walkman is connected to a computer, observe the following cautions. Otherwise, the Walkman may not function properly.
 - Do not turn on the computer.
 - Do not restart the computer.
 - Do not wake the computer from sleep mode.
 - Do not shut down the computer.
- The Walkman may become hot while charging. This is not a malfunction.
- The battery indicator scale does not correspond exactly to the remaining battery level. Refer to the battery indicator as a guide.
- When you charge the Walkman using a computer, do not remove the USB cable while data is transferring. If you disconnect the USB cable, data on the Walkman may be lost.

The contents of the Help Guide may be subject to change without notice due to updates to the product's specifications.

Related Topic

- [Charging the battery](#)
-

Extending the battery life

- Notes on the built-in battery
- Battery life

4-593-855-11(1) Copyright 2016 Sony Corporation

Digital Music Player
NW-WM1A/WM1Z

Using a microSD card

This topic includes instructions for the following operations.

- Inserting a microSD card into the Walkman.
- Removing a microSD card from the Walkman.
- Formatting a microSD card on the Walkman.

To use a microSD card on the Walkman, you first need to format the microSD card on the Walkman.

1 Insert a microSD card.

Open the microSD card slot cover (1).

Insert a microSD card until it clicks into place (2). Make sure to insert the microSD card in the correct direction. The gold contact pins should face up.

Close the cover (1).

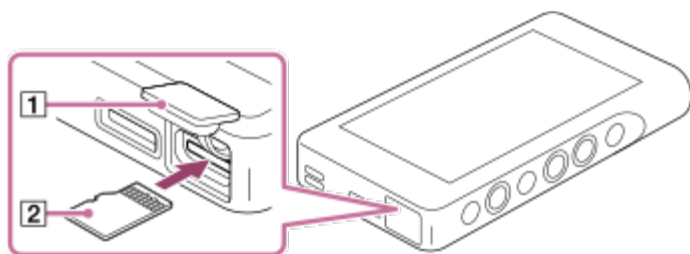

The Walkman will start updating the database.
When the update is complete, the library screen will appear.

2 Format the microSD card.

Tap the menu items in the following order.

☰ – [Settings] – [Device Settings] ([Basic Settings]) – [Reset/Format] – [Format SD Card].

Follow the onscreen instructions. Make sure to confirm the messages carefully.

To remove the microSD card

Before you remove a microSD card from the Walkman, first unmount the microSD card from the Walkman.

1. On the library screen, tap the menu items in the following order.

☰ – [Settings] – [Device Settings] ([Basic Settings]) – [Mount/Unmount SD Card] – [OK].

2. Open the microSD card slot cover. Make sure that the access lamp (1) is turned off.

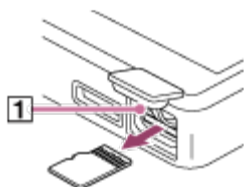

3. Push the microSD card into the microSD card slot.
The microSD card will pop out.
4. Remove the microSD card. Then, close the microSD card slot cover.

Note

- On the Walkman, you cannot exchange data between the Walkman memory and a microSD card.
- If the Walkman does not recognize the microSD card, remove and reinsert the microSD card into the Walkman.
- Do not insert any object other than a microSD card into the microSD card slot.
- If the inserted microSD card contains a large amount of data, it may take about 10 minutes or longer for the Walkman to update the database.
- When you remove the microSD card, the following information will be deleted.
 - The content that is currently being played.
 - The playback position.
 - Tracks and the playback order on the lineup screen
 - Bookmark information for tracks on the microSD card.
- Formatting a microSD card will delete all data stored on the microSD card. Save a back up copy of important data.

The contents of the Help Guide may be subject to change without notice due to updates to the product's specifications.

Related Topic

- [Notes on microSD cards](#)
- [Formatting a microSD card](#)

Digital Music Player
NW-WM1A/WM1Z

Notes on microSD cards

- Use a microSD card that has been formatted on the Walkman. Sony does not guarantee the operation of other microSD cards.
- Sony does not guarantee all operations for microSD cards that are used on multiple devices.
- Formatting a microSD card will delete all data stored on the microSD card. Save a backup copy in advance.
- Do not leave a microSD card within the reach of small children. Small children may accidentally swallow the microSD card.
- Unmount the microSD card ([Mount/Unmount SD Card]) from the Walkman before you remove a microSD card. Otherwise, the Walkman may not function properly.
- Sony does not guarantee the operation of all types of compatible microSD cards with the Walkman.
- Data may be corrupted in the following situations.
 - When a microSD card is removed during a read or write operation.
 - When the Walkman is turned off during a read or write operation.
 - When a microSD card is used in a location where there is static electricity or electrical noise.
- Sony assumes no responsibility for any loss or damage of stored data. Sony recommends that you save a backup copy of important data regularly.
- Observe the following cautions when you handle microSD cards.
 - Do not apply strong force to a microSD card.
 - Do not bend a microSD card.
 - Do not drop a microSD card.
 - Do not disassemble a microSD card.
 - Do not modify a microSD card.
 - Do not expose a microSD card to water.
 - Do not leave a microSD card in the hot interior of a car.
 - Do not leave a microSD card in direct sunlight.
 - Do not leave a microSD card near a heater.
 - Do not leave a microSD card in a humid place.
 - Do not leave a microSD card in a location where corrosive substances are present.
- Observe the following cautions regarding the microSD card slot.
 - Insert microSD cards into the microSD card slot in the correct direction.
 - Do not insert any object other than a microSD card into the microSD card slot.

The contents of the Help Guide may be subject to change without notice due to updates to the product's specifications.

Related Topic

- [Using a microSD card](#)
- [Formatting a microSD card](#)

Digital Music Player
NW-WM1A/WM1Z

Parts and controls

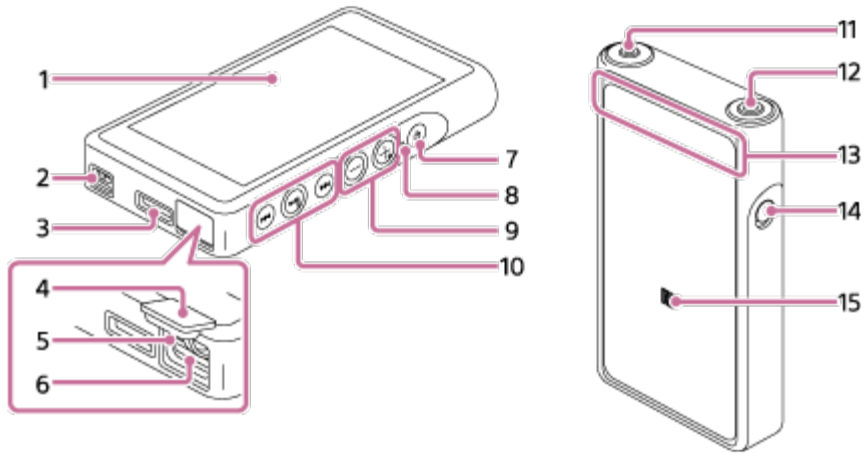

1. Touch screen

Tap icons or items on the screen to operate the Walkman.

2. Strap hole

Attach a wrist strap (supplied).

3. WM-PORTR jack

- Connect the USB cable (supplied).
- Connect accessories that support WM-PORTR (not supplied).

4. microSD card slot cover

Open the cover to insert a microSD card.

5. Access lamp

Do not remove the microSD card when the access lamp is lit up.

6. microSD card slot

Insert a microSD card until it clicks into place.

7. ⏻ (power) button

- Press the button to turn the screen on or off.
- Hold down the button for 3 seconds to turn the Walkman on or off.
- If operations become unstable, hold down the button for 8 seconds to restart the Walkman.

8. Charge lamp

The lamp lights up while the Walkman is charging.

9. Volume + (*1)/- buttons

Press the buttons to adjust the volume.

10 Playback operating buttons

- ▶|| (*1): Press the button to start or pause playback.
- ◀◀ / ▶▶: Press the buttons to jump within the current track or to the previous or next track. Hold down the buttons to fast-rewind or to fast-forward playback.

11 Headphone jack (Stereo Mini) (*2)

- Connect headphones with a stereo mini plug. Push in the headphone plug until it clicks into place. Connect the headphones properly. Otherwise, the output sound will be impaired.

12 Headphone jack (Balanced Standard) (*2)

- Connect headphones with a balanced standard plug. Push in the headphone plug until it clicks into place. Connect the headphones properly. Otherwise, the output sound will be impaired. Connect passive headphones (*3) to the headphone jack (balanced standard) only. If you use an audio cable to connect the headphone jack (balanced standard) to the line-in jack of an audio device, it may damage the device.

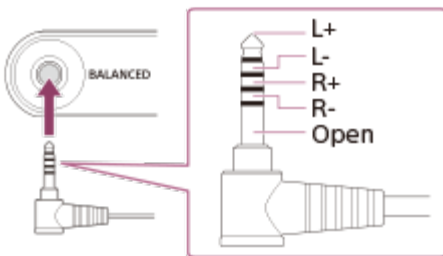

The internal circuit of the Walkman uses a relay. When a pair of headphones is connected to the headphone jack (balanced standard), you may hear sound from the relay in the following cases.

- When you change the output device.
- When you change the content or the sound quality settings.
- When you turn the power on or off.
- While the screen is off.

13 Built-in Bluetooth antenna

- The antenna allows the Walkman to connect with Bluetooth devices. Do not cover the antenna when a Bluetooth connection is active. Otherwise, the connection may be interrupted.

14 HOLD switch

- Slide the switch to lock the operating buttons on the Walkman. This lets you avoid operating the buttons accidentally. Locked (inoperable)



Released (operable)



15 N-mark

- Touch the N-mark on a Bluetooth device to this mark.
The Bluetooth device must support the NFC function.
You can connect the Bluetooth device to the Walkman.
- *1 There are tactile dots on the ►|| button and the volume + button. The tactile dots can help you operate the buttons without looking at them.
- *2 When headphones are connected to both headphone jacks (stereo mini and balanced standard), output from one headphone jack (balanced standard) will be prioritized.
Disconnect from the Bluetooth connection to use wired headphones.
- *3 Passive headphones: Headphones without a Noise Canceling function or Bluetooth function.

The contents of the Help Guide may be subject to change without notice due to updates to the product's specifications.

How to use the various screens on the Walkman

This topic explains the layout of the various screens with the playback screen (A) at the center. Flick the playback screen (A) to switch to other screens (up/down/left/right).

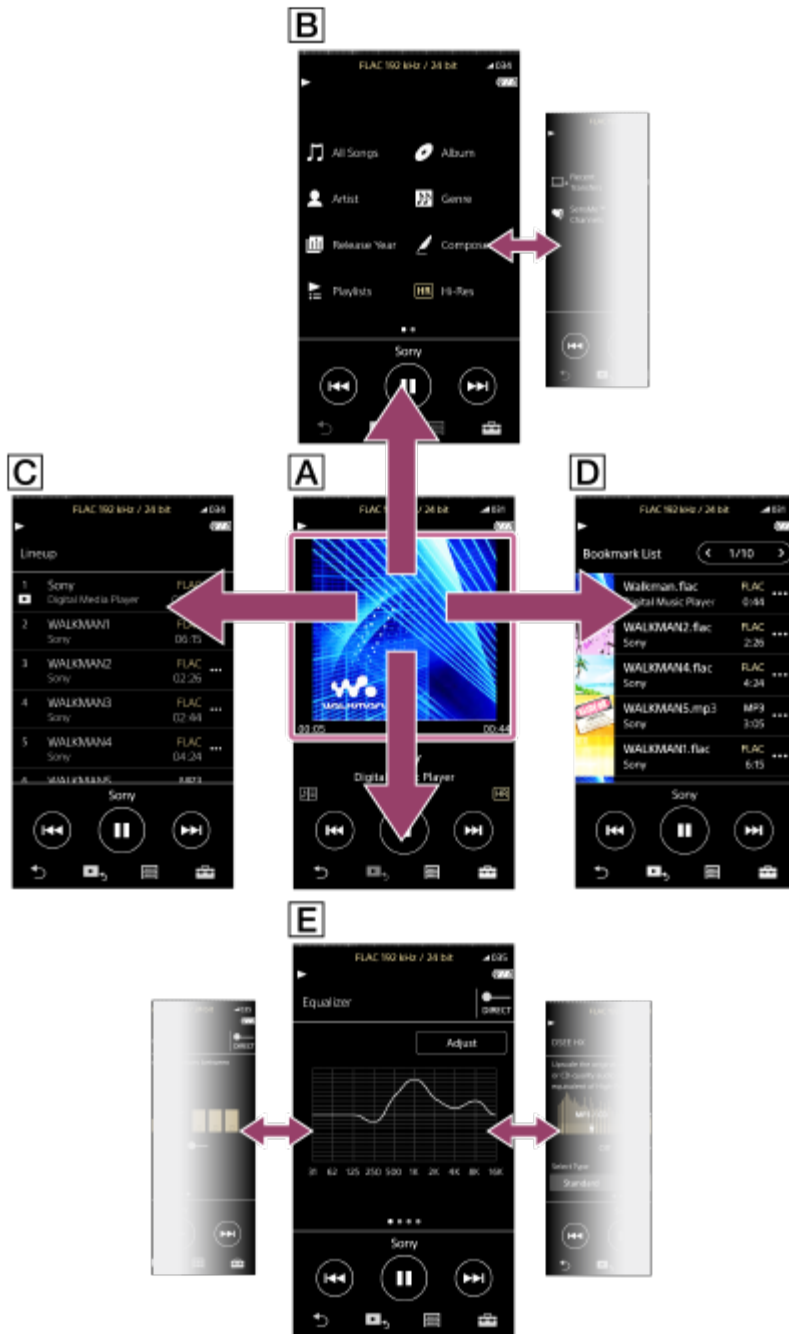

A Playback screen

You can control playback operations from the playback screen. You can also configure various settings for playback.

B Library screen

You can select tracks from the library screen. Tracks are classified into various categories (such as [All Songs], [Album], [Artist], etc.).

C Lineup screen

You can check the list of tracks that the Walkman will play with the current settings.

D Bookmark List screen

You can listen to tracks that you have registered to a bookmark list beforehand.

You can add tracks to bookmark lists on the playback screen, etc.

The following operations can be performed from this screen.

- Adding tracks to a bookmark list.
- Removing tracks from a bookmark list.
- Changing the order of tracks in a bookmark list.
- Adding tracks to playlists.

E Sound quality setting screens

You can adjust various sound quality settings.

You can save sound quality settings as presets. Up to 3 presets can be stored.

- Equalizer/Tone Control
- DSEE HX
- DC Phase Linearizer
- Dynamic Normalizer

Hint

- You can also configure sound quality settings from the menu. Tap the menu items in the following order.



 – [Settings] – [Sound Settings] ([Sound]).

Basic operating buttons

There are 4 basic operating buttons at the bottom of each screen. These buttons may not always be active depending on the screen.









-  (back)
Tap the button to return to the previous screen.

-  (go to playback screen)
Tap the button to return to the playback screen.
-  (library)
Tap the button to display the library screen.
-  (options/settings)
Tap the button to display the option/setting menus.
You can configure various settings for the Walkman.
Available menu items may differ depending on the screen or settings. To configure the basic settings for the Walkman, select the [Settings] menu.

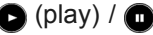
Basic playback operating buttons

There are basic playback operating buttons in the lower area of each screen.



-  (play) /  (pause)
Tap  to start playback.
While the Walkman is playing a track, tap  to pause playback.
-  (fast-rewind)
Tap the button to go back to the beginning of the current track or previous track. Hold down the button to fast-rewind playback.
-  (fast-forward)
Tap the button to jump to the beginning of the next track. Hold down the button to fast-forward playback.

The contents of the Help Guide may be subject to change without notice due to updates to the product's specifications.

Related Topic

- [Library screen](#)
- [Playback screen](#)
- [Lineup screen](#)
- [Bookmark List screen](#)
- [Sound quality setting screens](#)
- [Playback methods](#)

Digital Music Player
NW-WM1A/WM1Z

Library screen

You can select tracks from the library screen. Tracks are classified into various categories (such as [All Songs], [Album], [Artist], etc.).

To display the library screen

Flick the playback screen down.

You can also tap at the bottom of the screen to display the library screen.



1. Music categories ([All Songs], [Album], [Artist], etc.)
Each track is classified into several categories. Select a track from the desired category.
2. Page indicator
The number of dots represents the number of available pages.
3. Subcategories
After you select a music category, select a subcategory until you find the desired track.
You can check the codecs for tracks, such as FLAC. Codecs for High-Resolution Audio formats appear in color.

Option/setting menu

Tap to display the menu.

Available menu items may differ depending on the screen or settings.

Settings	Select the item to display the Settings menu.
Select Items to Display	Select the item to set which categories to display or not to display.
Reset display item order	Select the item to display the default categories.
View Help	Select the item to view the operating guide.

Pop-up menu

Tap **...** to display the pop-up menu. **...** appears beside each item in a subcategory list. Available menu items may differ depending on the screen or settings.

Add to Bookmark List	Select the item to add a track or subcategory item to the bookmark list.
Add to Playlist	Select the item to add a track or subcategory item to a playlist.
Delete	Select the item to delete the selected track, folder, or playlist.
Edit Playlist Name	Select the item to change the playlist name.
Delete from Playlist	Select the item to remove the selected track from the playlist.

Hint

- You can drag-and-drop the category icons to change the order.
- You can also display the pop-up menu by holding down an item in the list.

The contents of the Help Guide may be subject to change without notice due to updates to the product's specifications.

Related Topic

- [How to use the various screens on the Walkman](#)
- [Playing music](#)

Digital Music Player
NW-WM1A/WM1Z

Playback screen

You can control playback operations from the playback screen. You can also configure various settings for playback.

To display the playback screen

Tap  at the bottom of the screen.



1. Cover art
2. Track number / Total numbers of tracks
3. Elapsed time of the current track
4. Timeline bar
5. Track title / Artist name / Album title
6. Lyrics icon
7. Previous button / Play (Pause) button / Next button
8. Length of the track
9. Hi-Resolution Audio icon

Hint

- You can select the playback screen from three different layouts.

- Standard
- Spectrum Analyzer
- Analog Level Meter

Tap  and then [Change Playback Screen].

[Spectrum Analyzer] or [Analog Level Meter] will not be displayed when a Bluetooth connection is active.

- Drag the timeline bar to change the playback position in a track.

Note









- The elapsed time and timeline bar indications may not be accurate.
- The Walkman may not display cover art depending on the file format.

Option/setting menu

Tap  to display the menu.

Available menu items may differ depending on the screen or settings.

Scroll through the menu dialog to display the items listed below.

 Settings	Select the item to display the Settings menu.
 Repeat	Select the item to repeat the current track.
 Shuffle	Select the item to play tracks in random order.
 Add to Bookmark List	Select the item to add the current track to a bookmark list.
 Add to Playlist	Select the item to add the current track to a playlist.
 Change Playback Screen	Select the item to change the layout of the playback screen.
 Detailed Song Information	Select the item to display the details of the current track.
 Display Lyrics	Select the item to display the lyrics of the current track.
 View Help	Select the item to view the operating guide.

The contents of the Help Guide may be subject to change without notice due to updates to the product's specifications.

Related Topic

- [How to use the various screens on the Walkman](#)
- [Playing music](#)
- [Playback methods](#)
- [Displaying lyrics](#)
- [Adjusting the sound quality settings](#)

Digital Music Player
NW-WM1A/WM1Z

Lineup screen

You can check the list of tracks that the Walkman will play with the current settings.

To display the lineup screen

Flick the playback screen to the right.





1. Current track
2. Playback order
3. Pop-up menu icon
4. Track information
 - Artist name
 - Track title
 - Codec
Codecs for High-Resolution Audio formats appear in color.
 - Length

Option/setting menu

Tap  to display the menu.

Available menu items may differ depending on the screen or settings.

 Settings	Select to display the Settings menu.
 Add All Songs to Bookmark List	Select the item to add the current track lineup to a bookmark list.
 Add All Songs to Playlist	Select the item to add the current track lineup to a playlist.

Pop-up menu

Tap  to display the pop-up menu.
Available menu items may differ depending on the screen or settings.

Add to Bookmark List	Select the item to add the selected track to the bookmark list.
Add to Playlist	Select the item to add the selected track to a playlist.

Hint

- You can also display the pop-up menu by holding down an item in the list.

The contents of the Help Guide may be subject to change without notice due to updates to the product's specifications.

Related Topic

- [How to use the various screens on the Walkman](#)
- [Playing music](#)
- [Playback methods](#)
- [Managing playlists on the Walkman](#)
- [Managing bookmarks on the Walkman](#)

Digital Music Player
NW-WM1A/WM1Z

Bookmark List screen

You can listen to tracks that you have registered to a bookmark list beforehand.
You can add tracks to bookmark lists on the playback screen, etc.

To display the bookmark list screen

Flick the playback screen to the left.



1. Track information

- Cover art
- Artist name
- Track title
- Codec
- Length

2. Number of the current list

The previous list and the next list buttons



3. Pop-up menu icon

Option/setting menu

Tap to display the menu.

Available menu items may differ depending on the screen or settings.

Settings	Select the item to display the Settings menu.
Edit Song Order	Select the item to change the order of tracks in the selected bookmark list. Drag-and-drop until they are in the desired order.
Add All Songs to Bookmark	Select the item to add all tracks in the selected bookmark list to another bookmark

 List	list.
 Add All Songs to Playlist	Select the item to add all tracks in the selected bookmark list to a playlist.
Delete All	Select the item to remove all tracks from the selected bookmark list.

Pop-up menu

Tap  to display the pop-up menu.

Available menu items may differ depending on the screen or settings.

Add to Another Bookmark List	Select the item to add the selected track to another bookmark list.
Add to Playlist	Select the item to add the selected track to a playlist.
Delete from Bookmark List	Select the item to remove the selected track from the current bookmark list.

Hint

- You can also display the pop-up menu by holding down an item in the list.

Note

- When you remove a microSD card from the Walkman, tracks on the microSD card will be removed from the bookmark list.

The contents of the Help Guide may be subject to change without notice due to updates to the product's specifications.

Related Topic

- [How to use the various screens on the Walkman](#)
- [Playing music](#)
- [Playback methods](#)
- [Managing playlists on the Walkman](#)
- [Managing bookmarks on the Walkman](#)

Digital Music Player
NW-WM1A/WM1Z

Sound quality setting screens

You can adjust various sound quality settings.

You can save sound quality settings as presets. Up to 3 presets can be stored.

To display the sound quality setting screen

Flick the playback screen up.

To navigate the sound quality setting screens

Flick the screen left or right to select the sound quality setting that you want to adjust.

Tap the DIRECT switch to turn off the [Direct Source (DIRECT)] function so that you can flick the screen.

Adjustable sound quality settings

- Equalizer/Tone Control
- DSEE HX
- DC Phase Linearizer
- Dynamic Normalizer

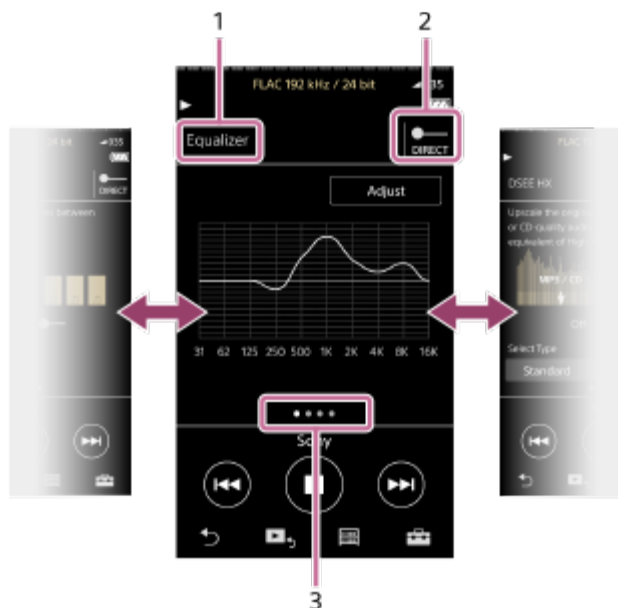

1. Name of the sound quality setting

2. DIRECT switch

You can turn the [Direct Source (DIRECT)] function on or off.

3. Page indicator

The number of dots represents the number of available pages. Flick the screen to the left or right to switch to a different page.

Option/setting menu

Tap  to display the menu.

Available menu items may differ depending on the screen or settings.

Saved Sound Settings	Select the item to save or retrieve customized settings.
Tone Control	Select the item to switch from the Equalizer screen to the Tone Control screen.
Equalizer	Select the item to switch from the Tone Control screen to the Equalizer screen.

Hint

- You can flick any of the sound quality setting screens down to return to the playback screen.

The contents of the Help Guide may be subject to change without notice due to updates to the product's specifications.

Related Topic

- [How to use the various screens on the Walkman](#)
- [Adjusting the sound quality settings](#)

Digital Music Player
NW-WM1A/WM1Z

List of icons displayed in the information area

You can check the playback status and various settings using the icons displayed in the information area. The icons vary depending on the status of the Walkman.

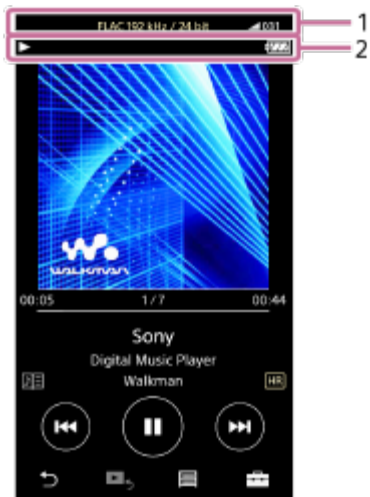









1. Volume bar

	Volume indicator Tap the volume bar to open the volume dialog. You can turn the volume knob to adjust the volume.
	AVLS
	Codec, sampling frequency, and bit depth/bit rate The indicator for High-Resolution Audio formats appears in color.
	BALANCED indicator The indicator appears when headphones are connected to the headphone jack (balanced standard).
	Volume status

2. Information area

	Playback status Play, pause, find the beginning of the next track, find the beginning of the current or previous track
--	---

	HOLD indicator
	Shuffle indicator (Shuffle Playback)
 	Repeat indicators (Repeat All/Repeat 1 Song)
	Sleep Timer
	Bluetooth
	NFC
	Battery status

The contents of the Help Guide may be subject to change without notice due to updates to the product's specifications.

Digital Music Player
NW-WM1A/WM1Z

Adjusting the volume

Adjusting the volume

On the Walkman: Press the button (1) to adjust the volume.

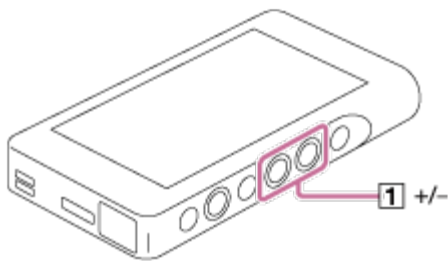

On the screen: Tap the volume bar (1) on the playback screen to display the volume dialog. Turn the knob (2) to adjust the volume. Tap 3 to close the volume dialog.

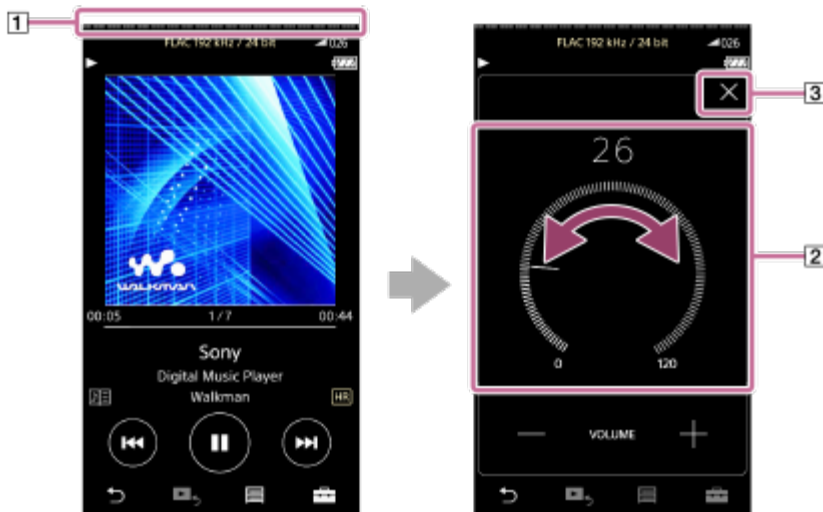

Hint

- You can also use the +/- buttons at the bottom of the volume dialog to adjust the volume.
- The volume may be low when you use certain headphones. In this case, switch the output setting to [High Gain Output]. To change the setting, tap the menu items in the following order.
☰ – [Settings] – [Output Settings] ([Basic Settings]) – [High Gain Output] ([Headphone Output]).
Then, tap the appropriate item for the headphones that you are using. (The menu item is only available on models sold in certain countries or areas.)
- When you switch between the headphone jack (balanced standard) and the headphone jack (stereo mini), the volume may become unexpectedly loud. To avoid loud volumes, the Walkman may lower the volume automatically.

Limiting the volume

The AVLS (Automatic Volume Limiter System) function reduces the risk of damage to ears from loud volumes. Using AVLS limits the maximum volume.

AVLS has the following features.

- AVLS limits the volume to a certain level.
- AVLS prevents disturbances to others caused by loud volumes.
- AVLS allows you to listen at a more comfortable volume.

1. Tap the menu items in the following order.

 – [Settings] – [Output Settings] ([Basic Settings]).

2. Tap [AVLS (Volume Limit)] ([Headphone Output]) to add a check mark.

Note

- [AVLS (Volume Limit)] does not work while there is an active Bluetooth connection.

Volume operation (Only for countries/areas complying with European Directives)

The alarm (beep) and warning [Check the volume level] are intended to protect your ears. They occur when you initially turn the volume up to a harmful level. You can cancel the alarm and warning by tapping [OK] on the alert dialog.

Note

- You can turn up the volume after you cancel the alarm and warning.
- After the initial warning, the alarm and warning will repeat every 20 cumulative hours that the volume is set to a level that is harmful to your ears. When this happens, the volume will turn down automatically.
- Protect your ears in the following ways:
 - Turn off the Walkman and take a break.
 - Turn down the volume.
- The alarm will not sound when there is an active Bluetooth connection.

The contents of the Help Guide may be subject to change without notice due to updates to the product's specifications.

Digital Music Player
NW-WM1A/WM1Z

Browsing the operating guide

You can browse the operating guide to take a quick tour of the operations on the Walkman.

- 1 On the library screen or the playback screen, tap  and then [View Help].**

The contents of the Help Guide may be subject to change without notice due to updates to the product's specifications.

Digital Music Player
NW-WM1A/WM1Z

Preparing music content

Before you transfer music content to the Walkman, you need to prepare the content. This topic includes instructions for the following operations.

- Importing content from an audio CD to Media Go.
- Importing content stored on a computer to Media Go.
- Importing content stored on an external media device to a computer.
- Purchasing content from online music services.

The instructions below are for operations using Media Go. Media Go is the recommended software for the Walkman. Install Media Go in advance.

Note

- Imported content is limited to private use only. Use of content for other purposes requires the permission of the copyright holders.
- If you are using a Mac computer, use Content Transfer for Mac.

Importing content from an audio CD to Media Go

1. Use a computer on which Media Go has been installed.
2. Launch Media Go.



3. Insert an audio CD into the media drive of the computer.
The content on the audio CD will appear on the Media Go screen.
4. Click [Import CD].
The audio CD will be imported to Media Go.



5. When importing the audio CD is completed, open [Library] – [Music] on Media Go to check the imported content.

Music information

Media Go will download music information automatically from the CDDB (Gracenote CD DataBase) via the Internet. The music information is used after the content is transferred to the Walkman.

Note the following when you use the CDDB service.

- CDDB provides music information (such as album titles, artist names, and track titles).
- Gracenote provides music information for free. When you use the Gracenote service for the first time, registration may be required.
- If you cannot obtain music information from CDDB, antivirus software may be blocking the information from downloading. In this case, adjust the software settings as necessary.
- CDDB may not have music information for some CDs. In this case, you cannot obtain information for the CDs. However, you can manually input music information using Media Go. For details on operation, refer to the online help information for Media Go.

Hint

- You can also use iTunes instead of Media Go to import audio CDs.
- The recommended file formats for importing CDs are as follows.
 - For higher sound quality: FLAC
 - For normal sound quality: AAC (.mp4), MP3 (.mp3)
- Media Go can simultaneously import and transfer an audio CD. Connect the Walkman to a computer. Then, insert an audio CD into the computer. When the content on the audio CD appears in Media Go, drag-and-drop the cover art (1) to [WALKMAN (model name)] (2).

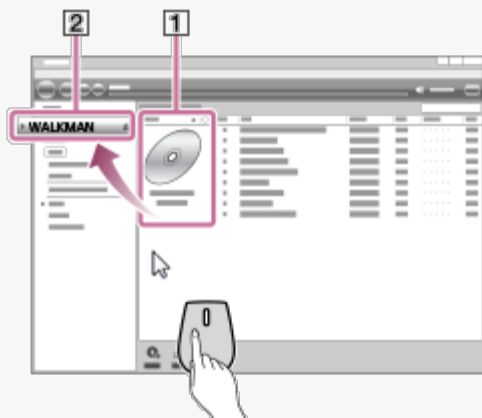

Importing content stored on a computer to Media Go

1. Use a computer on which Media Go has been installed.
2. Launch Media Go.



3. In Windows Explorer, open the folder that contains the music content.

4. Open [Library] – [Music] on Media Go (1).

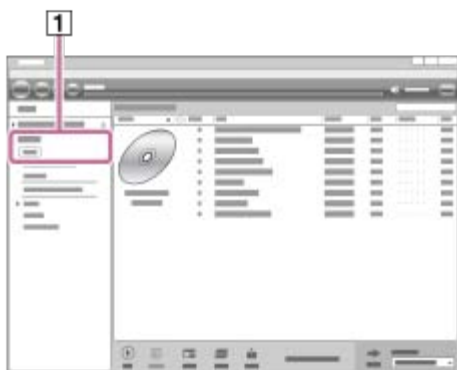

5. Drag-and-drop the folders or files from Windows Explorer to Media Go.



Importing content stored on an external media device to a computer

Use an external media device that contains music content.

The following instructions are for Windows Explorer. If you are using a Mac computer, use Finder.

1. Connect the external media device to a computer.
2. Open the external media device in Windows Explorer.
3. Open the [Music] folder of the computer in Windows Explorer.
4. Drag-and-drop the folders or files from the external media device to the [Music] folder on the computer.

Purchasing content from online music services

You can purchase music content from online music services.

Check the service guide for the provider you use. Each service provider has different downloading procedures, compatible file formats, and payment methods. Note that the provider may choose to suspend or terminate the service without notice.

The contents of the Help Guide may be subject to change without notice due to updates to the product's specifications.

Related Topic

- [Installing Media Go \(Windows\)](#)

- Installing Content Transfer (Mac)
- Transferring content from a Windows computer using Media Go
- Transferring content using Windows Explorer
- Transferring content from a Mac computer using Content Transfer
- Transferring content using Mac Finder
- Playing music

Digital Music Player
NW-WM1A/WM1Z

Purchasing High-Resolution Audio content

High-Resolution Audio refers to content in a format with higher sound quality than the CD standard. High-Resolution Audio content is available via online music services.

Access an online music service that provides High-Resolution Audio content. Services vary by country or area. Check the service guide for the provider you use. Each service provider has different downloading procedures, compatible file formats, and payment methods.

Note that the provider may choose to suspend or terminate the service without notice.

To transfer High-Resolution Audio content to the Walkman

- On a Windows computer: Use Media Go or Windows Explorer.
- On a Mac computer: Use Content Transfer or Finder.

Hint

- **HR** will appear beside the track title or album title on the Walkman and in Media Go.
- You can browse High-Resolution Audio content only. In Media Go, click **>**, and then select an appropriate item.



The contents of the Help Guide may be subject to change without notice due to updates to the product's specifications.

Related Topic

- [Installing Media Go \(Windows\)](#)
- [Installing Content Transfer \(Mac\)](#)
- [Transferring content from a Windows computer using Media Go](#)
- [Transferring content using Windows Explorer](#)
- [Transferring content from a Mac computer using Content Transfer](#)

- [Transferring content using Mac Finder](#)

4-593-855-11(1) Copyright 2016 Sony Corporation

Digital Music Player
NW-WM1A/WM1Z

Transferring content from a Windows computer using Media Go

You can transfer content that is stored on a Windows computer to the Walkman via Media Go.

1 Use a computer on which Media Go has been installed.

2 Launch Media Go.



3 Connect the Walkman to the computer via USB.

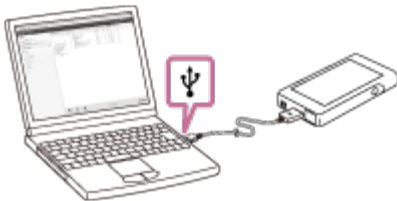

4 Open [Library] – [Music] (1) in Media Go.

Select a category (2) if necessary.

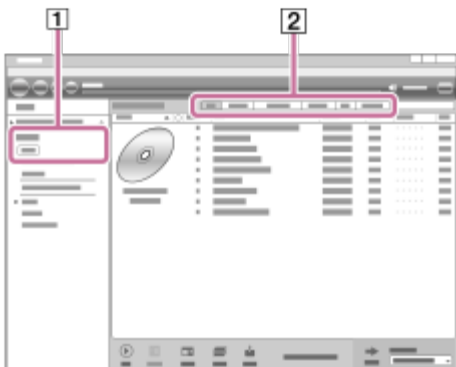



5 Select albums or tracks.





6 Make sure that [WALKMAN (model name)] is displayed as the destination (3).

Click [WALKMAN (model name)] (3) to select the destination memory.

- : The internal memory of the Walkman
- : A microSD card in the Walkman



7 Click 4 to transfer.

When the transfer is complete, the icon 5 will change from  to . Disconnect the Walkman from computer.



To transfer content from iTunes to the Walkman

Connect the Walkman to the computer via USB.

Launch iTunes, select the desired content in iTunes (1), and then drag-and-drop the content to [WALKMAN (model name)] (2) in Media Go.

If you want to select the destination memory, click the memory icon next to [WALKMAN (model name)] (2) before you transfer content.

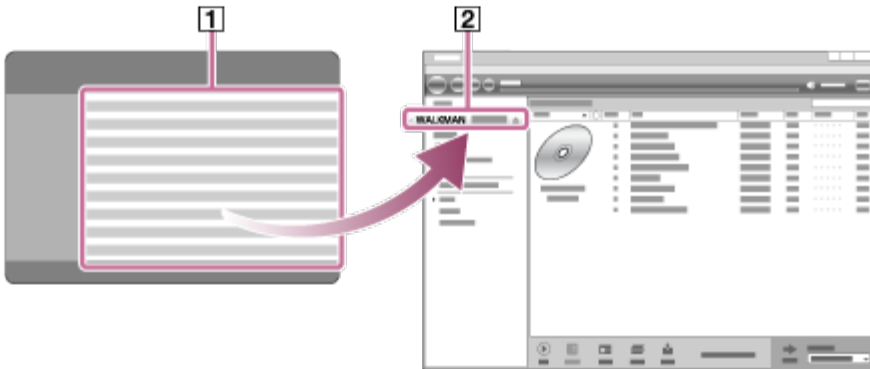

Hint

- You can also transfer playlists created in iTunes to the Walkman.
 1. Use iTunes to export playlists in m3u file format.
 2. Import the m3u files to Media Go.
 3. Transfer the playlists to the Walkman.
- For details on transferring content, refer to the online help information for Media Go.

Note

- Media Go does not support the following content.
 - Content with copyright protection.
 - Content that uses Windows Media digital rights management technology (WM-DRM).
- Do not disconnect the USB cable during data transfer. Otherwise, the data may be damaged.
- Transferred content is limited to private use only. Use of content for other purposes requires the permission of the copyright holders.
- On the Walkman, you cannot exchange data between the Walkman memory and a microSD card.

The contents of the Help Guide may be subject to change without notice due to updates to the product's specifications.

Related Topic

- [Installing Media Go \(Windows\)](#)
- [Preparing music content](#)
- [Purchasing High-Resolution Audio content](#)

- Transferring content using Windows Explorer
- Playing music

4-593-855-11(1) Copyright 2016 Sony Corporation

Digital Music Player
NW-WM1A/WM1Z

Transferring content using Windows Explorer

You can transfer content directly by dragging and dropping it from Windows Explorer.

1 Connect the Walkman to the computer via USB.

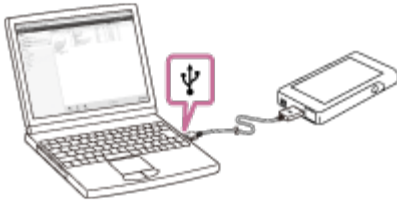

2 Open the [WALKMAN] folder as follows.

- Windows 7 or earlier versions:
Select [Start], [Computer], and then [WALKMAN].
- Windows 8.1:
Open [File Explorer] from [Desktop]. Select [WALKMAN] from the list under [This PC].
- Windows 10:
Open [File Explorer] from the [Start] menu. Select [WALKMAN] from the left pane.

You can also transfer content to a microSD card.
Select the folder with the name of the microSD card instead of [WALKMAN].

3 Open the [MUSIC] folder in [WALKMAN].

4 Drag-and-drop the files or folders on the computer to the [MUSIC] folder.

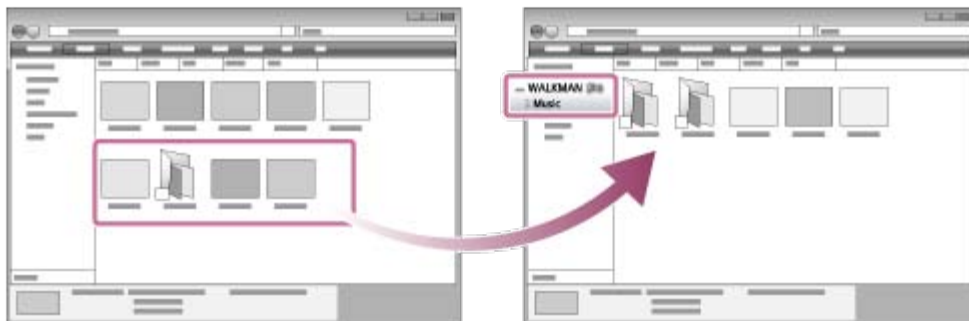

Confirm that the transfer is complete. Then, disconnect the Walkman from the computer.

Note

- Observe the following precautions. Otherwise, the Walkman may not be able to play the files.
 - Do not change the names of the root folders (such as [MUSIC]).
 - Do not transfer the files to folders other than [MUSIC].
 - Do not disconnect the USB cable during data transfer.
 - Do not format the memory of the Walkman on the computer.
- The Walkman may not play some files due to copyright protection.
- The Walkman may not display music information for some content correctly depending on the language setting on the Walkman.
- Transferred content is limited to private use only. Use of content for other purposes requires the permission of the copyright holders.

The contents of the Help Guide may be subject to change without notice due to updates to the product's specifications.

Related Topic

- [Preparing music content](#)
- [Purchasing High-Resolution Audio content](#)
- [Transferring content from a Windows computer using Media Go](#)
- [Playing music](#)

Digital Music Player
NW-WM1A/WM1Z

Importing content from the Walkman to Media Go

1 Use a computer on which Media Go has been installed.

2 Launch Media Go.



3 Connect the Walkman to the computer via USB.

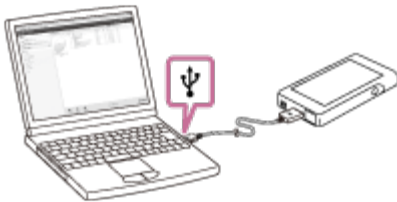

4 Click > (1) beside the name of the Walkman and select [MUSIC] in the left pane.



You can browse the content on the Walkman.

5 Select the content that you want to import to Media Go.

If you want to import albums or artists, select a category (2).

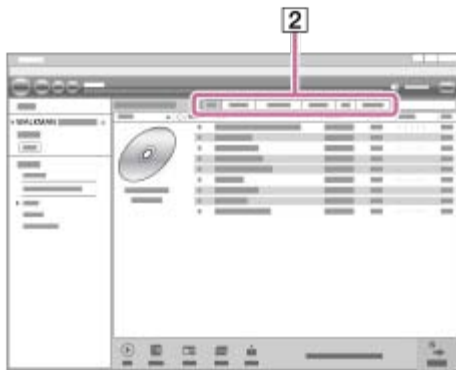

6 Click 3 in Media Go.



Confirm that the import of the content is complete. Then, disconnect the Walkman from the computer.

Hint

- For details on using Media Go, refer to the online help information for Media Go.

Note

- Check the audio format of the content that you want to import. If Media Go does not support the audio format, the content cannot be imported. For details on supported audio formats, refer to the online help information for Media Go.
- Do not disconnect the USB cable during data transfer. Otherwise, the data may be damaged.
- Imported content is limited to private use only. Use of content for other purposes requires the permission of the copyright holders.

The contents of the Help Guide may be subject to change without notice due to updates to the product's specifications.

Related Topic

- [Installing Media Go \(Windows\)](#)
- [Playing music](#)
- [Supported formats](#)

4-593-855-11(1) Copyright 2016 Sony Corporation

Digital Music Player
NW-WM1A/WM1Z

Transferring content from a Mac computer using Content Transfer

You can use Content Transfer for Mac. Content with copyright protection cannot be transferred.

1 Use a computer on which Content Transfer has been installed.

2 Launch Content Transfer.



3 Connect the Walkman to the computer via USB.

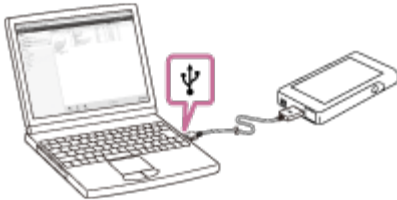

4 Select the destination memory on the Walkman (the internal memory or a microSD card).

5 Open Finder or iTunes. Then, select the content.

6 Drag-and-drop the content into Content Transfer.

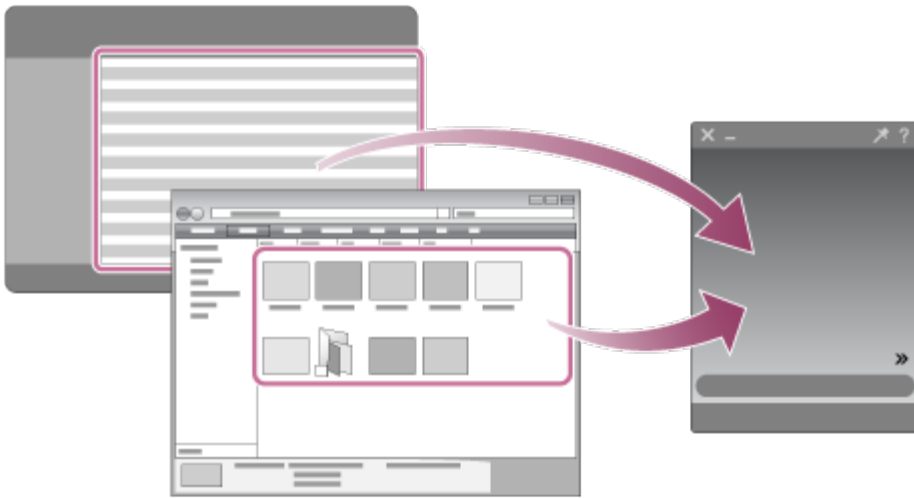

Confirm that the transfer is complete. Then, disconnect the Walkman from the computer.

Note

- Operation may not be guaranteed depending on the version of iTunes.
- Do not disconnect the USB cable during data transfer. Otherwise, the data may be damaged.
- Transferred content is limited to private use only. Use of content for other purposes requires the permission of the copyright holders.

The contents of the Help Guide may be subject to change without notice due to updates to the product's specifications.

Related Topic

- [Installing Content Transfer \(Mac\)](#)
- [Preparing music content](#)
- [Purchasing High-Resolution Audio content](#)
- [Playing music](#)

Digital Music Player
NW-WM1A/WM1Z

Transferring content using Mac Finder

You can transfer content directly by dragging and dropping it from Finder.

1 Connect the Walkman to a running computer via USB.



2 Select [WALKMAN] in the sidebar of the Finder.

You can also transfer content to a microSD card.
Select the folder with the name of the microSD card instead of [WALKMAN].

3 Open the [MUSIC] folder in [WALKMAN].

4 Drag-and-drop the files or folders (1) to the [MUSIC] folder (2) in [WALKMAN].

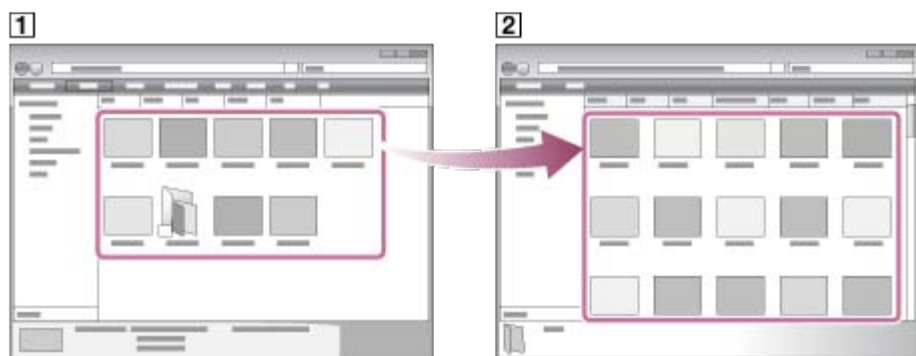

Confirm that the transfer is complete. Then, disconnect the Walkman from the computer.

Note

- Observe the following precautions. Otherwise, the Walkman may not be able to play the files.
 - Do not change the names of the root folders (such as [MUSIC]).
 - Do not transfer the files to folders other than [MUSIC].
 - Do not disconnect the USB cable during data transfer.
 - Do not format the memory of the Walkman on the computer.
- The Walkman may not display music information for some content correctly depending on the language setting on the Walkman.
- Transferred content is limited to private use only. Use of content for other purposes requires the permission of the copyright holders.

The contents of the Help Guide may be subject to change without notice due to updates to the product's specifications.

Related Topic

- [Installing Content Transfer \(Mac\)](#)
- [Preparing music content](#)
- [Purchasing High-Resolution Audio content](#)
- [Playing music](#)

Digital Music Player
NW-WM1A/WM1Z

Adding lyrics information using a computer

To add lyrics information, you can select either of the following methods.

- Adding lyrics to a track using the latest version of Media Go.
- Creating lyrics in a text file (an LRC file).

After you input lyrics to tracks, transfer the tracks to the Walkman.

Adding lyrics to a track with Media Go

You can edit lyrics information using Media Go.

In Media Go, open [Properties] for a track, and then select the lyrics tab to add lyrics information. For details on editing lyrics, refer to the online help information for Media Go.

Note

- After you input lyrics information to tracks in Media Go, transfer the tracks to the Walkman again.

Creating lyrics in a text file (LRC file)

1. Open the [Notepad] in Windows Accessories.
2. Enter the lyrics into [Notepad].
3. Play the track and enter the time to display each line of text.

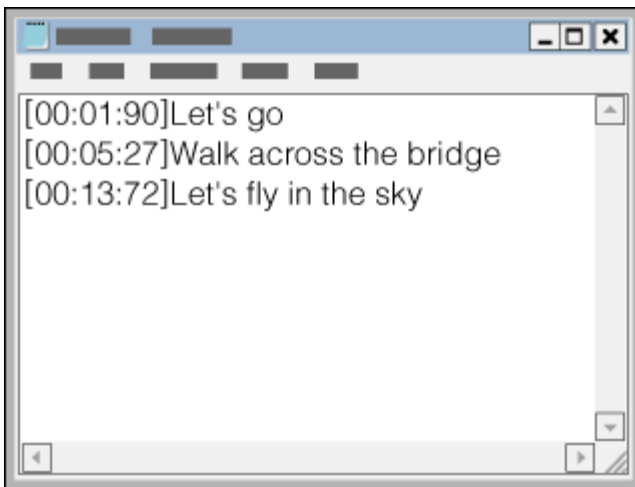

- You can enter the time information to the left of each line of text in the following format.
Minutes:seconds:hundredths of a second (*1)
- Time information must be entered in chronological order.
- You can separate seconds and hundredths of a second using a period instead of a colon.

*1 You can omit hundredths of a second.

4. Save the file.

- Select [UTF-8] as the character encoding.
- Set the same file name as the audio file.
- Set [.lrc] as the extension.
- The maximum file size is 512 KB.
- If a text line cannot fit on the screen, it will be wrapped.
- The number of lines of text that can be displayed simultaneously depends on the Walkman model.
- CR, CRLF, and LF line breaks are all recognized.
- Blank text lines will be skipped.

5. Connect your Walkman to the computer via USB.

6. Open the [WALKMAN] folder according to one of the following procedures.

- Windows 7 or earlier versions:
Select [Start], [Computer], and then [WALKMAN].
- Windows 8.1:
Open [File Explorer] from [Desktop]. Select [WALKMAN] from the list under [This PC].
- Windows 10:
Open [File Explorer] from the [Start] menu. Select [WALKMAN] from the left pane.

You can also transfer content to a microSD card.

Select the folder with the name of the microSD card instead of [WALKMAN].

7. Create a new folder in the [MUSIC] folder under [WALKMAN]. Then, drag-and-drop both the track and the LRC file into the new folder to transfer them.

Hint

- The following numbers of characters are recommended when you display lyrics on the Walkman.
 - Single-byte characters (for example, alphanumeric characters): 40 characters per line.
 - 2-byte characters (for example, Chinese characters): 20 characters per line.
- On a Mac computer, you can create lyrics using “TextEdit” and other text editors. Follow the same procedure as that described above to enter the lyrics or time information in the “Plain text” setting.

Copyright notice

When you create LRC files using copyrighted materials authored by others, the LRC files are limited to private use only. Use of LRC files for other purposes requires the permission of the copyright holders.

The contents of the Help Guide may be subject to change without notice due to updates to the product's specifications.

Related Topic

- [Obtaining lyrics information](#)

- [Displaying lyrics](#)

4-593-855-11(1) Copyright 2016 Sony Corporation

Digital Music Player
NW-WM1A/WM1Z

Notes on transferring content from a computer

Drag-and-drop content into the correct folder as shown in the following illustration. The Walkman can playback content stored in the first through eighth level of each folder.



Note

- Do not rename the following default folders. Otherwise, the Walkman will not recognize the folders.
 - MUSIC

The contents of the Help Guide may be subject to change without notice due to updates to the product's specifications.

Digital Music Player
NW-WM1A/WM1Z

Playing music

To play tracks, first select a category.
You need to transfer music content from a computer to the Walkman in advance.

On a Windows computer

- Use Media Go to transfer content from a CD or the computer to the Walkman.
- Drag-and-drop content from Windows Explorer.

On a Mac computer

- Use Content Transfer to transfer content from iTunes.
- Drag-and-drop content from Finder.

1 Tap  to open the library screen.

2 Tap the desired category ().

You can flick the screen to the left or right to switch pages. The number of dots represents the number of available pages ().



3 Select subcategories until a track list appears, and then select the desired track.

Playback will start.

Manual buttons on the Walkman

Operation button	Function
▶	Press the button to start or pause playback.
◀◀	Press the button to skip to the beginning of the current track or the previous track. Hold down the button to fast rewind the track while playing.
▶▶	Press the button to skip to the beginning of the next track. Hold down the button to fast forward the track while playing.

Note

- If the Walkman does not play tracks in the order you want, try the following.
 - Use the bookmark function on the Walkman.
 - Create playlists with Media Go or iTunes and transfer them.

The contents of the Help Guide may be subject to change without notice due to updates to the product's specifications.

Related Topic

- [Turning the Walkman on or off](#)
- [How to use the various screens on the Walkman](#)
- [Installing Media Go \(Windows\)](#)
- [Library screen](#)
- [Playback screen](#)
- [Preparing music content](#)
- [Transferring content from a Windows computer using Media Go](#)
- [Transferring content using Windows Explorer](#)
- [Transferring content from a Mac computer using Content Transfer](#)
- [Transferring content using Mac Finder](#)
- [Playback methods](#)

Digital Music Player
NW-WM1A/WM1Z

Playback methods

This topic includes instructions for the following operations.

- Setting the playback mode.
- Setting the playback range.

Setting the playback mode

1. On the playback screen, tap  and then [Repeat] or [Shuffle].
2. Tap the desired playback mode.

Setting the playback range





1. Tap the menu items in the following order.
 – [Settings] – [Playback Settings] ([Basic Settings]).
2. Tap the desired playback range from [Playback Range].

Diagram of the relationship between playback mode and playback range

Play Mode	Playback Range	
	All Range	Selected Range
 Shuffle Playback	All tracks are played in random order. To shuffle all the tracks on the Walkman, select [All Songs] on the library screen. If you select a track from [Album] on the library screen, the Walkman will shuffle all the tracks in the selected album. When the Walkman finishes playing all the tracks in the album, playback will proceed to the next album. Then, the Walkman will shuffle all the tracks in the album.	Tracks in the selected range are played in random order. (*1)
Repeat Off	All tracks are played in sequential order.	Tracks in the selected range are played in sequential order. (*1)
 Repeat 1 Song	The current track is played repeatedly.	The current track is played repeatedly.
 Repeat All	All tracks are played repeatedly. To repeat all the tracks on the Walkman, select [All Songs] on the library screen.	Tracks in the selected range are played repeatedly. (*1)

*1 "Selected range" means one album or one artist, for example.

Note

- When you play a track using the [SensMe™ Channels] function, you cannot change the playback mode.
- When you select a track from a bookmark list, the Walkman plays tracks in the selected bookmark list only. Tracks in other bookmark lists will not be played even when [Playback Range] is set to [All Range].
- When you select a track from a playlist, the Walkman plays tracks in the selected playlist only. Tracks in other playlists will not be played even when [Playback Range] is set to [All Range].

The contents of the Help Guide may be subject to change without notice due to updates to the product's specifications.

Related Topic

- [How to use the various screens on the Walkman](#)
- [Playback screen](#)
- [Playing music](#)

Digital Music Player
NW-WM1A/WM1Z

Using [SensMe™ Channels]

The [SensMe™ Channels] function automatically groups tracks by theme. You can play tracks to suit your mood, current activity, the time of day, and more.

To use the [SensMe™ Channels] function on the Walkman, tracks must be analyzed by Media Go before you transfer the tracks. For details on operation, search [SensMe™ Channels] in the online help information for Media Go.

1 On the library screen, tap [SensMe™ Channels].

Hint

- [SensMe™ Channels] implements the following technologies developed by Sony.
 - 12 TONE ANALYSIS on the Walkman using Low-Complexity Music Information Retrieval (LCMIR) technology
 - Music file transfer from software and devices that support the 12 TONE ANALYSIS technology
- When you open a channel using the [SensMe™ Channels] function or switch to a different channel, the track is played starting from the most melodic or rhythmical section.
- Tracks are played in random order. Each time you select a channel, the order of playback will be different.

Note

- The Walkman only displays channels that contain tracks.

The contents of the Help Guide may be subject to change without notice due to updates to the product's specifications.

Related Topic

- [Library screen](#)

Digital Music Player
NW-WM1A/WM1Z

Obtaining lyrics information

If you transfer tracks with lyrics information, you can view the lyrics on the Walkman.

There are two methods of inputting lyrics information.

- Adding lyrics to a track using Media Go.
- Creating lyrics in a text file (an LRC file).

Both of the methods above must be performed on a computer. Add lyrics on the computer, and then transfer the tracks to the Walkman.

The contents of the Help Guide may be subject to change without notice due to updates to the product's specifications.

Related Topic

- [Displaying lyrics](#)
- [Adding lyrics information using a computer](#)

Digital Music Player
NW-WM1A/WM1Z

Displaying lyrics

Transfer tracks with lyrics information to the Walkman. Then, set the Walkman to display lyrics. When lyrics information is available for a track, an icon (1) lights up.

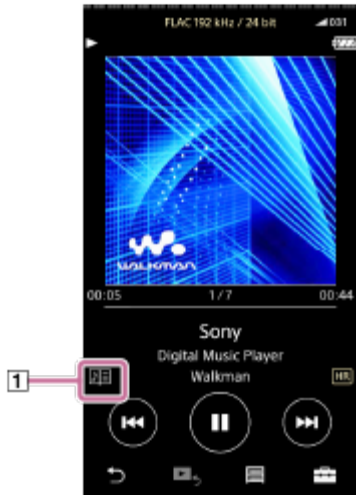

1 On the playback screen, tap  and then [Display Lyrics].

The contents of the Help Guide may be subject to change without notice due to updates to the product's specifications.

Related Topic

- [Obtaining lyrics information](#)
- [Adding lyrics information using a computer](#)

Digital Music Player
NW-WM1A/WM1Z

Managing playlists on the Walkman



You can collect your favorite tracks and save them as playlists on the Walkman. This topic includes instructions for the following operations.

- Adding tracks to playlists on the Walkman.
- Listening to playlists on the Walkman.
- Deleting playlists from the Walkman.

Adding tracks to playlists on the Walkman

Playlists can be saved either in the internal memory of the Walkman or on the microSD card. You cannot add a track from the internal memory to a playlist on the microSD card or vice versa.





1. Perform one of the following.

- While the Walkman is playing or pausing a track that you want to add to a playlist:
On the playback screen, tap  and then [Add to Playlist].
- When a list (track list, album list, track lineup, etc.) is displayed:
Tap  beside the desired item in the list to display the pop-up menu. Then, tap [Add to Playlist].

The playlist selection screen will appear.

2. Tap the playlist name to add the track.

Hint

- Up to 999 tracks can be added to a playlist.
- You can change the order of tracks in a playlist. Select a playlist from the library screen. Tap  and then [Edit Song Order]. Drag-and-drop  to rearrange the tracks. Tap [Complete] to save the order of tracks.
- You can change the name of a playlist from the pop-up menu. On the library screen, tap [Playlists]. Tap  beside the desired playlist and then [Edit Playlist Name].
- You can transfer playlists created using Media Go or iTunes to the Walkman. Playlists in the m3u file format can be managed on the Walkman.
- You can create a new playlist on the Walkman. To create a new playlist, tap the menu items in the following order:
 – [Add to Playlist] – [New Playlist].
Then, name the playlist and tap [Complete] to finish.

Note

- You cannot register cover art images for playlists.

Listening to tracks in a playlist on the Walkman

1. On the library screen, tap [Playlists].
2. Tap the desired playlist and then tap the desired track.

Deleting playlists from the Walkman

1. On the library screen, tap [Playlists] to display the list of playlists.
2. Tap  beside the playlist that you want to delete, and then tap [Delete].
3. Follow the onscreen instruction.

Hint

- You can remove a track from a playlist.
Display the list of tracks in the playlist and tap  to display the pop-up menu. Then, select [Delete from Playlist].

Note

- Even if you delete a playlist, the tracks in the playlist will not be deleted from the Walkman.

The contents of the Help Guide may be subject to change without notice due to updates to the product's specifications.

Related Topic

- [Library screen](#)
- [Playback screen](#)
- [Lineup screen](#)
- [Bookmark List screen](#)

Digital Music Player
NW-WM1A/WM1Z

Managing bookmarks on the Walkman



You can add your favorite tracks to bookmark lists. Up to 10 bookmark lists are available. Up to 999 tracks can be added to a bookmark list.

This topic includes instructions for the following operations.

- Adding tracks to bookmark lists.
- Listening to bookmarked tracks on the Walkman.
- Removing tracks from a bookmark list on the Walkman.

Adding tracks to bookmark lists



1. Perform one of the following.

- While the Walkman is playing or pausing a track that you want to bookmark:
On the playback screen, tap  and then [Add to Bookmark List].
- When a list (track list, album list, track lineup, etc.) is displayed:
Tap  beside the desired item in the list to display the pop-up menu. Then, tap [Add to Bookmark List].

The bookmark list selection screen will appear.

2. Select the desired bookmark list.

Hint

- You can add a whole list to a bookmark list. When the lineup screen or the bookmark list screen is displayed, tap  and then [Add All Songs to Bookmark List].
- You can change the order of tracks in a bookmark list.
Select a bookmark list. Tap  and then [Edit Song Order]. Drag-and-drop  to rearrange the tracks. Tap [Complete] to save the order of tracks.

Note

- You cannot import bookmark lists to a computer.

Listening to bookmarked tracks on the Walkman

1. Display the bookmark list screen.

2. Tap / to select a list, and then select a track.

Removing tracks from a bookmark list on the Walkman

1. Tap beside the track in a bookmark list.

2. Tap [Delete from Bookmark List].

Hint

- You can remove all the tracks from a bookmark list.
On the bookmark list screen, tap  and then [Delete All].

The contents of the Help Guide may be subject to change without notice due to updates to the product's specifications.

Related Topic

- [Library screen](#)
- [Playback screen](#)
- [Lineup screen](#)
- [Bookmark List screen](#)

Digital Music Player
NW-WM1A/WM1Z

Deleting tracks from the Walkman

You can delete tracks from the Walkman.

1 On the library screen, display one of the following items.

- To delete tracks, tap the desired category (albums, artists, etc.), the desired subcategory, and then the desired track.
- To delete a folder, tap [Folder] and then the desired folder.

2 Tap to display the pop-up menu and tap [Delete].

Follow the onscreen instructions.

Hint

- You can delete tracks using a computer as well.

Note

- When you delete tracks using a computer, do not delete or rename the root folder (such as [MUSIC]). Otherwise, the Walkman will not recognize the content.

The contents of the Help Guide may be subject to change without notice due to updates to the product's specifications.

Related Topic

- [Library screen](#)

Digital Music Player
NW-WM1A/WM1Z

Viewing a guide to enjoy high quality sound

You can view information on enjoying content in high sound quality.

- 1 On the playback screen, tap the menu items in the following order.**
 – [Settings] – [Guide to High Quality Sound] ([Sound]).

The contents of the Help Guide may be subject to change without notice due to updates to the product's specifications.

Related Topic

- [Library screen](#)
- [Sound quality setting screens](#)
- [Adjusting the sound quality settings](#)

Digital Music Player
NW-WM1A/WM1Z

Connecting the Walkman to an unpaired Bluetooth device for the first time

The Bluetooth function enables wireless connections between devices. The devices need to support Bluetooth wireless technology. A wireless connection is possible at a range of up to 10 meters in an open area.

You can use the Bluetooth function for the following operations.

- Listening to music.

Connect a Bluetooth device such as headphones or speakers. You can listen to music wirelessly.

Before you use the Walkman with a Bluetooth device, pair the Walkman and the device. Once the Walkman and the device are paired, you can easily connect the devices in the future.

The following instructions are a basic step-by-step procedure for connecting the Walkman and a Bluetooth device.

1 Turn on the Bluetooth function on the Bluetooth device, if necessary.

2 On the library screen, tap the menu items in the following order.

☰ – [Settings] – [Connect to/Add Audio Device] ([Bluetooth]).

The Bluetooth connection screen will appear.

3 Tap the Bluetooth switch ([1]) to turn on the Bluetooth function and tap [Add Device (Pairing)] ([2]).

📶 will appear in the information area. A list of the connectable devices will appear on the screen ([3]).

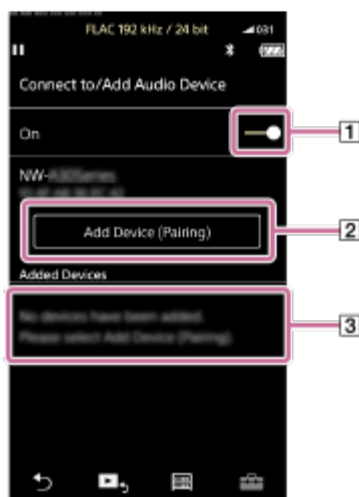

4 Tap the Bluetooth device.

If you are required to enter a passkey while pairing, check and enter the passkey for the Bluetooth device. For details on the passkey for the Bluetooth device, refer to the manual of the device.

When the connection is established, [Connected] will appear in .

5 From the library screen, select and play a track.

The sound will be output from the connected Bluetooth device.

To disconnect from a paired Bluetooth device

1. While the Bluetooth device is connected, tap the menu items in the following order.
 – [Settings] – [Connect to/Add Audio Device] ([Bluetooth]).
2. Tap the name of the Bluetooth device from [Added Devices].

Hint

- You can delete registered Bluetooth device. On the list of connectable devices in [Added Devices], tap  beside the name of a Bluetooth device. Then, select [Delete Device].
- The passkey may also be called a “passcode”, “PIN code”, “PIN number”, or “password”.
- The Walkman can stay connected to a Bluetooth device until you turn off the Bluetooth function. When you are not using the Bluetooth function, turn off the Bluetooth function.

Note

- The battery life becomes considerably shorter when the Bluetooth function is active.
- You can pair the Walkman with a maximum of 7 devices. If the number of paired devices exceeds the maximum, the Walkman will delete the oldest connected device.
- If the pairing times out before it is finished, perform the procedure again starting from the Bluetooth connection screen.
- There are some restrictions on sound output through a Bluetooth connection.
 - Even if you connect a pair of headphones to a headphone jack, sound will not be output from the headphones. Sound is output from the Bluetooth device preferentially.
- If sound is interrupted or skips during a Bluetooth connection, try the following.
 - Place the Walkman and the Bluetooth device closer together.
 - Select [SBC - Connection Preferred] by tapping the following menu items.
 – [Settings] – [Audio Device Connection Settings] ([Bluetooth]) – [Wireless Playback Quality].
- A Bluetooth connection is terminated automatically in the following cases:
 - The battery of the Walkman has run out.
 - The Walkman is turned off.
 - The Walkman is connected to a computer via USB (USB Mass Storage mode).
- When there is an active Bluetooth connection, the sound quality settings are invalid.

The contents of the Help Guide may be subject to change without notice due to updates to the product's specifications.

Related Topic

- [Connecting the Walkman to a paired Bluetooth device](#)
- [Establishing a Bluetooth connection using NFC](#)
- [Configuring the Bluetooth function](#)
- [Notes on the Bluetooth function](#)

Digital Music Player
NW-WM1A/WM1Z

Connecting the Walkman to a paired Bluetooth device

If the Walkman and a Bluetooth device have been paired before, the Bluetooth device is registered to the Walkman. You can connect the Walkman and the Bluetooth device easily.

1 Turn on the Bluetooth function on the Bluetooth device, if necessary.

2 On the library screen, tap the menu items in the following order.

 – [Settings] – [Connect to/Add Audio Device] ([Bluetooth]).

The Bluetooth connection screen will appear.

3 Tap the Bluetooth switch to turn on the Bluetooth function.

 will appear in the information area.

4 Tap the Bluetooth device.

When the connection is established, [Connected] will appear.

5 From the library screen, select and play a track.

To turn the Bluetooth function on or off

1. Tap the menu items in the following order.

 – [Settings] – [Connect to/Add Audio Device] ([Bluetooth]).

2. Tap the Bluetooth switch to turn the Bluetooth function on or off.

To confirm the information for a device:

Tap  beside the name of the Bluetooth device in the list and tap [Device Information].

To erase a registered device:

Tap  beside the name of the Bluetooth device in the list and tap [Delete Device].

Follow the onscreen instructions. The pairing information will be erased.

Hint

- A shortcut is available for the Bluetooth function. You can tap  on the [Settings] screen.
- If you connect a USB charger (not supplied), the Walkman will charge while maintaining the Bluetooth connection.
- If you connect the Walkman to a computer via USB, the Bluetooth connection will be terminated (USB Mass Storage mode).
- If multiple names for a Bluetooth device are displayed, check the BD address of the Bluetooth device. For details on the BD address, refer to the manual of the Bluetooth device.
- If the Bluetooth device supports the NFC function, the Walkman and the Bluetooth device can be paired and connected by touching them together.
- The Walkman can stay connected to a Bluetooth device until you turn off the Bluetooth function. When you are not using the Bluetooth function, turn off the Bluetooth function.

Note

- The battery life becomes considerably shorter when the Bluetooth function is active.
- There are some restrictions on sound output through a Bluetooth connection.
 - Even if you connect a pair of headphones to a headphone jack, sound will not be output from the headphones. Sound is output from the Bluetooth device preferentially.
- If sound is interrupted or skips during a Bluetooth connection, try the following.
 - Place the Walkman and the Bluetooth device closer together.
 - Select [SBC - Connection Preferred] by tapping the following menu items.
 -  – [Settings] – [Audio Device Connection Settings] ([Bluetooth]) – [Wireless Playback Quality].
- A Bluetooth connection is terminated automatically in the following cases:
 - The battery of the Walkman has run out.
 - The Walkman is turned off.
 - The Walkman is connected to a computer via USB (USB Mass Storage mode).
- When there is an active Bluetooth connection, the sound quality settings are invalid.

The contents of the Help Guide may be subject to change without notice due to updates to the product's specifications.

Related Topic

- [Connecting the Walkman to an unpaired Bluetooth device for the first time](#)
- [Establishing a Bluetooth connection using NFC](#)
- [Configuring the Bluetooth function](#)
- [Notes on the Bluetooth function](#)

Digital Music Player
NW-WM1A/WM1Z

Establishing a Bluetooth connection using NFC

If a Bluetooth device supports the NFC function, you can connect the Walkman and the device easily. You can simply touch the Walkman to the device to pair the devices and establish a Bluetooth connection.

NFC is for close-range wireless communications.

1 If the Bluetooth device has an NFC switch, set the NFC switch to on.

2 Turn on the Walkman screen.

3 Touch the mark on the Walkman (1) to the mark on the Bluetooth device (2).

Hold them together until instructions appear on the screen of the Walkman.

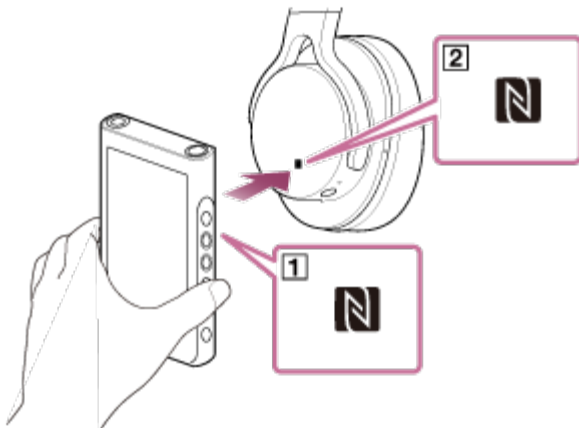

4 Follow the onscreen instructions on the Walkman to complete the connection.

5 Once the connection is established, play a track on the Walkman.

To disconnect the Walkman and the Bluetooth device using the NFC function

Turn on the Walkman screen. Then, touch the devices (**1** and **2**) together again to disconnect.

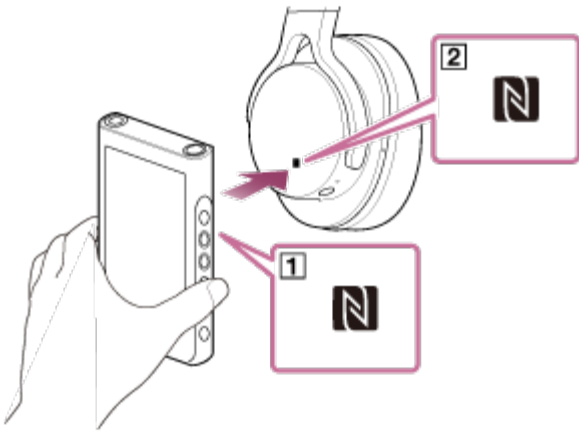

To turn off the NFC function

The NFC function is turned on as a default. If you want to turn off the NFC function, tap the menu items in the following order to remove the check mark.

 – [Settings] – [NFC] ([Bluetooth]).

Hint

- Take the following measures if the connection is poor.
 - Move the Walkman over the mark on the Bluetooth device (**2**).
 - If your Walkman is inside a case, take it out of the case.
 - Make sure that the NFC function is on. Tap  and then [Settings]. Confirm that there is a check mark in the check box for [NFC] ([Bluetooth]).

Note

- The battery life becomes considerably shorter when the Bluetooth function is active.

The contents of the Help Guide may be subject to change without notice due to updates to the product's specifications.

Related Topic

- [Turning the Walkman on or off](#)
- [Configuring the Bluetooth function](#)
- [Notes on the Bluetooth function](#)

Digital Music Player
NW-WM1A/WM1Z

Configuring the Bluetooth function

This topic includes instructions for the following operations.

- Selecting the playback quality for Bluetooth streaming.
- Checking Bluetooth information.

Selecting the playback quality for Bluetooth streaming

You can select the combination of codecs and preferences for Bluetooth streaming.

1. On the playback screen, tap the menu items in the following order.
 – [Settings] – [Audio Device Connection Settings] ([Bluetooth]) – [Wireless Playback Quality].
2. Tap the desired item.

Note

- The setting for [Wireless Playback Quality] will take effect starting the next time you turn on the Bluetooth function.
- The [Wireless Playback Quality] setting may not be effective depending on the settings of the Bluetooth device.

Checking Bluetooth information

1. On the playback screen, tap the menu items in the following order.
 – [Settings] – [Bluetooth Information] ([Bluetooth]).
- Information such as the Bluetooth version and profile will appear.

The contents of the Help Guide may be subject to change without notice due to updates to the product's specifications.

Related Topic

- [Connecting the Walkman to an unpaired Bluetooth device for the first time](#)
- [Connecting the Walkman to a paired Bluetooth device](#)
- [Establishing a Bluetooth connection using NFC](#)

Digital Music Player
NW-WM1A/WM1Z

Notes on the Bluetooth function

- To optimize Bluetooth communications, observe the following.
 - Place the Walkman and the Bluetooth device as close together as possible. The Bluetooth standard supports distances of up to 10 meters (32.8 feet).
 - Turn the built-in Bluetooth antenna (aerial) in the direction of the connected Bluetooth device.
 - Do not block the antenna (aerial) with a metal object such as a bag or case.
 - Do not block the antenna (aerial) with a body part such as a hand.
 - Do not block the antenna (aerial) by placing the Walkman inside a backpack or shoulder bag.
 - Do not block the antenna (aerial) by using the Walkman in a crowded place.
 - Avoid areas where electromagnetic waves are emitted. For example, near microwave ovens, mobile phones, mobile gaming devices, or wireless LAN environments.
- Due to a characteristic of Bluetooth wireless technology, the sound may lag slightly.
- Bluetooth radiation may affect the operation of electronic medical devices. Turn off the Walkman and other Bluetooth devices in the following locations.
 - in hospitals
 - near priority seats on trains
 - on airplanes
 - in places where flammable gases are present (gas stations, etc.)
 - near automatic doors
 - near fire alarms
- The Walkman supports security functions that comply with the Bluetooth standard. Sony bears no responsibility whatsoever for information leaks that occur as a result of your Bluetooth connection.
- Even if a Bluetooth device conforms to the standard, all connections and correct operations are not guaranteed.
- Depending on the Bluetooth device, it may take some time to establish a Bluetooth connection.

The contents of the Help Guide may be subject to change without notice due to updates to the product's specifications.

Related Topic

- [Parts and controls](#)

Digital Music Player
NW-WM1A/WM1Z

Adjusting the sound quality settings

The Walkman has various settings for adjusting the sound quality.

From the [Settings] menu

On the playback screen, tap  and then [Settings].
You can set the following sound settings from the menu listed under [Sound].

Direct Source (DIRECT)

This setting outputs the file's original sound quality directly without applying any sound effects.

Saved Sound Settings

- Save Current Settings:
You can save customized sound quality settings as your own sound presets.
- Saved Sound Settings 1/2/3:
You can retrieve preset sound quality settings.

From the [Settings] – [Sound Settings] menu

On the playback screen, tap the menu items in the following order.
 – [Settings] – [Sound Settings] ([Sound]).
You can also adjust the following settings from the sound quality setting screens.

Equalizer/Tone Control

You can customize the equalizer and tone control settings from their respective screens.
On the equalizer screen, tap [Adjust] to adjust the setting. On the tone control screen, rotate the dials to adjust the settings.
Tap  to select [Equalizer] or [Tone Control]. The selected setting will take effect.

DSEE HX

This function upscales the sound quality of audio files. The sound quality will become almost equal to that of High-Resolution Audio. The function reproduces the clear high-range sound that is often lost.
Select a sound type based on the source sound.

DC Phase Linearizer

This function adjusts low-frequency phase shifts to reproduce the audio characteristics of analog amplifiers.
Select a sound type for this setting.

Dynamic Normalizer

You can moderate the change in volume between tracks to minimize differences in volume level.

Note

- When there is an active Bluetooth connection, the sound quality settings are invalid.
- You cannot adjust [Sound Settings] in the following cases.
 - When [Direct Source (DIRECT)] is set to [On].

The contents of the Help Guide may be subject to change without notice due to updates to the product's specifications.

Related Topic

- [How to use the various screens on the Walkman](#)
- [Sound quality setting screens](#)

Digital Music Player
NW-WM1A/WM1Z

Using USB Mass Storage mode

When you connect the Walkman to a Windows computer, the following modes are available.

USB Mass Storage mode

- The computer uses the Walkman as a USB storage device.
- Data can be transferred between the computer and the Walkman.
- You can access the [WALKMAN] and [SD_CARD] folders directly to manage files.
- The Walkman charges via the computer.
- You cannot operate the Walkman.

USB mode

- The Walkman charges via the computer.
- You can operate the Walkman while the Walkman is connected to the computer.
- Data cannot be transferred.

This topic includes instructions for the following operations.

- Switching from USB Mass Storage mode to the USB mode
- Switching from USB mode to the USB Mass Storage mode

Switching from USB Mass Storage mode to USB mode

When you connect the Walkman to a computer, the Walkman enters USB Mass Storage mode.

1. Tap [Turn Off USB Mass Storage] (1).
The USB mode screen will appear.

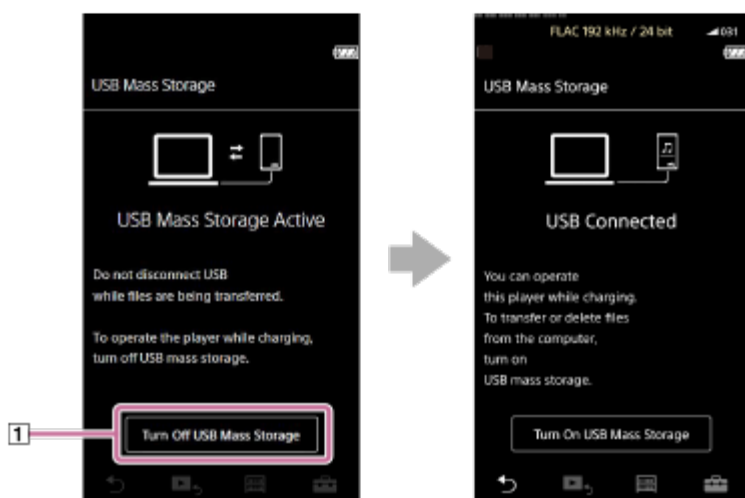

2. Tap .
The screen will return to the previous display.

Switching from USB mode to USB Mass Storage mode

1. Tap the menu items in the following order.

 – [Settings] – [Device Settings] ([Basic Settings]) – [USB Connection Settings] – [Turn On USB Mass Storage] – [OK].

Note

- Before you disable USB Mass Storage mode, we recommend that you perform [Safely Remove Hardware] on the computer.
- Do not disconnect the Walkman while transferring content between the Walkman and the computer. Doing so will damage the data. On the computer screen, confirm that the data has finished transferring properly.

The contents of the Help Guide may be subject to change without notice due to updates to the product's specifications.

Related Topic

- [Charging the battery](#)

Digital Music Player
NW-WM1A/WM1Z

Restarting the Walkman

Restart the Walkman if operations become unstable or the Walkman freezes. Restarting will not delete any data. However, perform the following before you restart the Walkman. Otherwise, the data on the Walkman may be damaged.

- Disconnect the Walkman from the computer.
- Stop playback.

1 Hold down the button () for 8 seconds until the Walkman restarts.

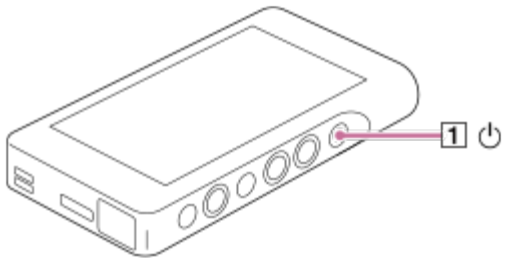

The contents of the Help Guide may be subject to change without notice due to updates to the product's specifications.

Related Topic

- [Resetting/Reformatting/Initializing the Walkman](#)
- [Formatting a microSD card](#)

Digital Music Player
NW-WM1A/WM1Z

Resetting/Reformatting/Initializing the Walkman

This topic includes instructions for the following operations.

- Resetting the Walkman.
- Reformatting the memory of the Walkman.
- Rebuilding the database on the Walkman.
- Initializing the Walkman.

Confirm the details of each function. Then, select the appropriate menu item for your needs.

- 1 On the library screen, tap the menu items in the following order.**
 – **[Settings]** – **[Device Settings] ([Basic Settings])** – **[Reset/Format]**.

- 2 Tap the operation that you want to execute.**

Follow the onscreen instructions. Make sure to confirm the messages carefully.

[Reset All Settings]	This operation resets all setting parameters to the default settings. If you select this operation, the Walkman will restart automatically.
[Format System Storage]	This operation reformats the internal memory of the Walkman. Note that all data (including sample data) stored on the Walkman will be deleted. Save a backup copy of important data.
[Rebuild Database]	This operation rebuilds the database on the Walkman. You can rebuild the database manually.
[Restore to Factory Configuration]	This operation initializes both the settings and internal memory. You can restore the Walkman to its default settings. All transferred data will be erased. However, the Walkman will restore its preinstalled sample content and installers as default settings. If you select this operation, the Walkman will restart automatically and the initial setup wizard will launch.

Hint

- Even if you perform [Reset All Settings], the following settings will not be changed.
 - Elapsed time of the selected track
 - Preset 1 through 3 for [Saved Sound Settings]
 - The bookmark list (1 through 10)
 - User settings for the library screen
 - Information on recently transferred content
 - Clock settings
 - Language settings
 - User setting for [Text Input]

Note

- Sony does not guarantee performance if you reformat the memory of the Walkman using a computer.
- If you execute [Restore to Factory Configuration]/[Reset All Settings], pairing information for Bluetooth devices will be deleted from the Walkman.
- If you rebuild the database, the following information will be erased.
 - Elapsed time of the selected track
 - Playback order

The contents of the Help Guide may be subject to change without notice due to updates to the product's specifications.

Related Topic

- [Restarting the Walkman](#)
- [Formatting a microSD card](#)

Digital Music Player
NW-WM1A/WM1Z

Formatting a microSD card

You can format a microSD card on the Walkman.

Formatting the microSD card will delete all data stored on the card. Save a backup copy in advance. Be careful not to delete important data.

1 On the library screen, tap the menu items in the following order.

 - **[Settings]** - **[Device Settings] ([Basic Settings])** - **[Reset/Format]** - **[Format SD Card]**.

Follow the onscreen instructions. Make sure to confirm the messages carefully.

Note

- Format the microSD card on the Walkman. Otherwise, some functions of the Walkman may be limited.

The contents of the Help Guide may be subject to change without notice due to updates to the product's specifications.

Related Topic

- [Restarting the Walkman](#)
- [Resetting/Reformatting/Initializing the Walkman](#)

Digital Music Player
NW-WM1A/WM1Z

Checking information on the Walkman

You can check information such as the model name and system software version.

- 1 On the library screen, tap the menu items in the following order.**
 – [Settings] – [Unit Information] ([Other]).

The contents of the Help Guide may be subject to change without notice due to updates to the product's specifications.

Related Topic

- [Updating the Walkman system software](#)

Digital Music Player
NW-WM1A/WM1Z

Updating the Walkman system software

You can update the software of the Walkman.
You will receive update notices by the following methods.

- From Media Go (You will receive update notices automatically.)
- From the customer support website (Access the site manually to receive update notices.)

Access the customer support website to get the latest information.
The following procedure describes how to update the software from the customer support website.
For details on how to install the program, refer to the customer support website.

1 Download the update program to a computer from the website.

2 Connect the Walkman to the computer.

3 Launch the update program.

4 Follow the onscreen instructions.

Hint

- To check the version information for the Walkman, tap the menu items in the following order.
 – [Settings] – [Unit Information] ([Other]).

The contents of the Help Guide may be subject to change without notice due to updates to the product's specifications.

Related Topic

- [Customer support website](#)
- [Restarting the Walkman](#)
- [Resetting/Reformatting/Initializing the Walkman](#)
- [Checking information on the Walkman](#)

4-593-855-11(1) Copyright 2016 Sony Corporation

Digital Music Player
NW-WM1A/WM1Z

Using shortcut buttons from the quick setting panel



Shortcut buttons for some functions are available in the quick setting panel. You can activate certain functions directly without scrolling in the [Settings] menu.

1 Tap  and then [Settings].

2 Tap the shortcut button for the desired function.



Available functions

Shortcut button	Function
	Tap the button to adjust the screen brightness. You can select a value from 1 to 100.
	Tap the button to turn the Bluetooth function on or off.
 (*1)	Tap the button to turn the Bluetooth remote control function on or off.

*1 This function is only available on models sold in certain countries or areas.

Note

- Pair the Walkman and the Bluetooth device (audio device or remote control) in advance.

The contents of the Help Guide may be subject to change without notice due to updates to the product's specifications.

Related Topic

- [Connecting the Walkman to an unpaired Bluetooth device for the first time](#)

4-593-855-11(1) Copyright 2016 Sony Corporation

Digital Music Player
NW-WM1A/WM1Z

Settings menu

You can adjust various settings from the Settings menu.
To enter the Settings menu, tap  and then [Settings].
You can select the Settings menu on the following screen.

- Library screen
- Playback screen
- Lineup screen
- Bookmark list screen

Basic Settings

Playback Settings	Play Mode
	Playback Range
	Sleep Timer
	Artist List Display
	Display Lyrics
Output Settings	Headphone Output
	USB Output for DSD
	DSD Playback Settings
Device Settings	Beep Settings (*1)
	Disable touch panel when the HOLD switch is on
	Screen Off Timer
	Mount/Unmount SD Card
	USB Connection Settings
	Battery Care
	Clock Settings
	Language Settings
	Text Input
	Reset/Format

*1 Operating sounds ([Beep Settings]) are not output in the following situations.

- While the Walkman is playing DSD tracks in the native format through balanced headphones. ([Play DSD in Native Format] is on.)
- While sound is being played back via a connected Bluetooth device.

Sound

Direct Source (DIRECT) (On/Off)	–
Sound Settings	Equalizer/Tone Control
	DSEE HX
	DC Phase Linearizer
	Dynamic Normalizer
Saved Sound Settings	Saved Sound Settings 1/2/3
Guide to High Quality Sound	–

Bluetooth

Connect to/Add Audio Device	On/Off
	Add Device (Pairing)
	Added Devices
Audio Device Connection Settings	Wireless Playback Quality
Remote Control Settings (*1)	On/Off
	Added Remote Control
	Add Remote Control
	Delete Remote Control
NFC (On/Off)	–
Bluetooth Information	Bluetooth Version/Device Name/Bluetooth Device Address/Profile/Version

*1 The menu item is only available on models sold in certain countries or areas.

Other

Unit Information	Model name, firmware version, total number of tracks, etc.
Certificates (*1)	Safety regulations/certification

*1 The menu item is only available on models sold in certain countries or areas.

The contents of the Help Guide may be subject to change without notice due to updates to the product's specifications.

4-593-855-11(1) Copyright 2016 Sony Corporation

Digital Music Player
NW-WM1A/WM1Z

Notes on handling the Walkman

Read the notes below and follow the instructions to use the Walkman safely.

- Consult a doctor if you become injured or burned from using the product.
- Contact the nearest Sony dealer or Sony Service Center if the Walkman does not operate properly.
- Observe the following precautions. Otherwise, an explosion, fire, electric shock, burns, or injury may result.
 - Do not expose the Walkman to fire.
 - Do not allow metallic objects to get inside the Walkman.
 - Do not short-circuit the terminals of the Walkman with metallic objects.
 - Do not take apart or modify the Walkman.
 - Do not use the Walkman when you see lightning or hear thunder.
 - Do not use the Walkman if it causes an uncomfortable reaction on your skin.
- Observe the following precautions. Otherwise, you may damage the casing or cause the Walkman to malfunction.
 - Do not place the Walkman in direct sunlight.
 - Do not place the Walkman in locations where the temperature is extremely high.
 - Do not leave the Walkman in direct sunlight. Do not leave the Walkman in a car with all the windows closed, especially during the summer.



- Do not place the Walkman in locations where it is exposed to vibration.
- Do not drop the Walkman from heights.
- Do not apply a strong force or shock to the Walkman.
- Do not place the Walkman in locations where there is magnetization. For example, do not place the Walkman near a magnet, speakers, or a TV.
- Do not turn on the Walkman right after you move it from a cold environment to a warm environment.
- Do not use the Walkman in damp locations, such as in a bathroom or a sauna.
- Do not place the Walkman on an unstable surface or in an inclined position.
- Do not sit down when the Walkman is inserted in your pocket.



- When you store the Walkman in a bag, do not apply strong impacts to the bag. In particular, avoid storing the Walkman in a bag with the headphone cord or earphone cord wrapped around the Walkman.



- The Walkman is neither waterproof nor dustproof. Observe the following precautions. Otherwise, the Walkman may become inoperable because of short-circuited terminals or corroded metal.
 - Do not drop the Walkman into water.
 - Do not use the Walkman in humid locations or during wet weather such as rain or snow.
 - Do not place the Walkman against your body or clothes when you are sweating.
 - Do not touch the Walkman with wet hands.



- Do not use the Walkman in locations where it is exposed to excessive dust.
- Comply with announcements regarding the use of electronic devices when you are on an airplane.
- Heat may build up in the Walkman in the following situations, but this is not a malfunction. However, be careful because there is a risk of low-temperature burns.
 - While the battery is charging.
 - While the Walkman is playing for an extended period of time.
- Do not apply strong force to the surface of the display. Strong force may cause the following problems.
 - Distorted colors or brightness.
 - A malfunction of the display.
 - Injury from a cracked display.
- When you use a strap, note the following.
 - The strap can get caught on objects around you. Be careful to avoid the risk of strangulation.
 - Be careful not to swing the Walkman while holding the strap. You may hit someone with the Walkman.
 - Use the supplied wrist strap.
- Content that you record is for personal use only. Under copyright law, the content cannot be used without the permission of the copyright holder.

The contents of the Help Guide may be subject to change without notice due to updates to the product's specifications.

Digital Music Player
NW-WM1A/WM1Z

Notes on the headphones

Road safety

Do not use headphones in the following situations.

- While you are driving a car or riding a motorcycle or bicycle.
- Places where impaired hearing is dangerous. For example, on train platforms, in areas where there is vehicle traffic, or near construction sites.

Preventing hearing damage

Observe the following to protect your hearing.

- Keep the volume at a moderate level. Do not listen to audio content at high volumes for an extended period of time.
- Do not turn up the volume suddenly.

About the in-ear headphones

- When you use in-ear headphones with a high degree of adhesion, note the following. Otherwise, you may damage your ears or eardrums.
 - Do not insert the earbuds forcefully into your ears.
 - Do not remove the earbuds from your ears suddenly. When you take off the headphones, move the earbuds up and down gently.
- When you unplug the headphones from the Walkman, hold the headphones by the plug. Pulling the cord itself may damage the headphones.
- Do not sleep while you are wearing headphones. The cord may become wrapped around your neck while you are sleeping.

Consideration for others

Avoid using the Walkman in environments where sound leakage will disturb others.

The contents of the Help Guide may be subject to change without notice due to updates to the product's specifications.

Digital Music Player
NW-WM1A/WM1Z

Notes on the built-in battery

Do not touch the rechargeable battery with your bare hands if the battery is leaking. The battery liquid may cause burns or blindness. If the liquid contacts your body or clothes, wash the liquid off immediately with clean water.

The contents of the Help Guide may be subject to change without notice due to updates to the product's specifications.

Digital Music Player
NW-WM1A/WM1Z

Notes on the software

- Copyright laws prohibit the following actions without the permission of the copyright holder.
 - Reproducing the software or the manual in whole or in part.
 - Loaning out the software

- In no event will Sony be held liable for any of the following incidents that may arise out of the use of the supplied software.
 - Financial damage
 - Loss of profits
 - Claims made by third parties

- The supplied software cannot be used with devices for which it is not designated.
- Please note that the software specifications may be changed without notice for quality improvement.
- The explanations in this manual assume that you are familiar with the basic operations of a computer.
- For details on the use of computers and operating systems, refer to their respective manuals.

The contents of the Help Guide may be subject to change without notice due to updates to the product's specifications.

Digital Music Player
NW-WM1A/WM1Z

General Information

- Charging time and playback time depend on the following conditions.
 - The number of times you have charged the battery
 - Operating temperature
- When the battery is sufficiently charged but the battery life has dropped to about half of its normal span, the battery may be worn out.
- A lithium-ion rechargeable battery is built into the Walkman. When you store the Walkman for long periods of time, check the following to prevent the deterioration of the built-in battery.
 - Store the Walkman at temperatures from 5 °C to 35°C (41 °F to 95 °F).
 - Charge the battery to approximately 50% of its capacity at least once every 6 months.



- When you use the Walkman in a cold location, the onscreen display may become dark or may not respond quickly. However, these are not malfunctions.
- You feel mild tingling against your ears particularly in dry air conditions.
This is a result of static electricity accumulated in the body.
This effect can be minimized by wearing clothes made from natural materials.
- Sample data is not installed in some countries or regions.
- Sony is not responsible for user data even if the following problems occur due to defects in the Walkman or a computer.
 - Recording or downloading of data is incomplete.
 - Data (music, photos, or movies) is damaged or deleted.

The contents of the Help Guide may be subject to change without notice due to updates to the product's specifications.

Digital Music Player
NW-WM1A/WM1Z

Maintenance

- Clean the Walkman with a soft cloth, such as a cleaning cloth for eyeglasses.
- To clean a Walkman that has gotten very dirty, use a cloth slightly moistened with a mild detergent solution. Be careful not to get water inside the Walkman.
- Do not clean with solvents such as alcohol, naphtha, or paint thinner. These solvents may damage the surface of the Walkman.
- Clean the headphone plug occasionally with a soft dry cloth. Noise or sound skipping may occur if the plug is dirty.
- (NW-WM1Z only)
This product contains gold plating with purity of about 99.7 % gold.
Wipe gently without rubbing strongly when you clean the product. The gold-plated parts are more sensitive than regular plated parts.
When you clean the product, Sony recommends working on a tabletop covered with a soft cloth to prevent scratches.

The contents of the Help Guide may be subject to change without notice due to updates to the product's specifications.

Digital Music Player
NW-WM1A/WM1Z

Customer support website

Visit the customer support website in your country or region in the following situations.

- When you have a question about the Walkman.
- When you have an issue with the Walkman.
- When you want information on compatible items.

For customers in the US:

<http://www.sony.com/walkmansupport>

For customers in Canada:

English

<http://www.sony.ca/ElectronicsSupport/>

French

<http://www.sony.ca/ElectronicsSupport/>

For customers in Latin America:

<http://www.sony-latin.com/index.crp>

For customers in Europe:

<http://www.sony.eu/dna/wm/>

For customers in Asia/Oceania/the Middle East/Africa:

English

<http://www.sony-asia.com/support>

Korean

<https://scs.sony.co.kr/scs/handler/ProductSupport>

Simplified Chinese

<https://service.sony.com.cn>

Traditional Chinese

<http://service.sony.com.tw/>

For customers who purchased the overseas models:

<http://www.sony.co.jp/overseas/support/>

The contents of the Help Guide may be subject to change without notice due to updates to the product's specifications.

4-593-855-11(1) Copyright 2016 Sony Corporation

Digital Music Player
NW-WM1A/WM1Z

Specifications

Display

Size/resolution	4.0-inch (10.2 cm) / FWVGA (854 × 480 Pixels)
Panel type	TFT color display with white LED-backlight Capacitive touch screen

Interface

USB	Hi-Speed USB (USB 2.0 compliant)
Headphone	Stereo mini-jack, Balanced standard-jack
WM-PORT	WM-PORT (multiple connecting terminal): 22 pins
External memory	microSD microSDHC microSDXC

Bluetooth

Bluetooth Specifications

Communication system	Bluetooth Specification Version 4.2
Frequency band	2.4 GHz band (2.4000 GHz - 2.4835 GHz)
Modulation method	FHSS
Compatible Bluetooth profiles (*1)	A2DP (Advanced Audio Distribution Profile) AVRCP (Audio Video Remote Control Profile)
Supported Codec (*2)	SBC (*3), LDAC

*1 Bluetooth profiles are standardized according to the purpose of the Bluetooth device.

*2 Codec indicates the audio signal compression and conversion format.

*3 SBC stands for Subband Codec.

Output (headphones)

Frequency	Frequency response 20 Hz to 40,000 Hz (when playing data file, single signal measurement)
-----------	---

General

Power Source	Built-in Rechargeable lithium-ion Battery USB power (from a computer via a USB connector of the player)
Charging Time	USB-based charging Approx. 7 hours
Operating temperature	5°C to 35°C (41 °F to 95 °F)
Dimensions (Walkman)	w/h/d, projecting parts not included Approx. 65.3 mm × 123.4 mm × 19.9 mm (2.58 inches × 4.86 inches × 0.79 inches)
	w/h/d Approx. 72.9 mm × 124.2 mm × 19.9 mm (2.87 inches × 4.89 inches × 0.79 inches)
Mass (Walkman)	NW-WM1Z Approx. 455 g (16.1 oz)
	NW-WM1A Approx. 267 g (9.5 oz)
Dimensions (Leather case) (NW-WM1Z only)	w/h/d, projecting parts not included Approx. 81 mm × 132 mm × 29 mm (31.9 inches × 52.0 inches × 11.5 inches)

Capacity

NW-WM1Z	256 GB
NW-WM1A	128 GB

Actual available memory for other contents (*1)

NW-WM1Z	Approx. 230.60 GB=247,612,538,880 byte
---------	--

NW-WM1A	Approx. 114.15 GB=122,573,127,680 byte
---------	--

*1 Available capacity may vary. A portion of the memory is used for data management functions.

The contents of the Help Guide may be subject to change without notice due to updates to the product's specifications.

4-593-855-11(1) Copyright 2016 Sony Corporation

Digital Music Player
NW-WM1A/WM1Z

Battery life

The values shown below are the approximate battery life when content is played continuously at the default settings.

Music (Approx.)

MP3 128 kbps	33 hours
AAC 256 kbps	31 hours
FLAC 96 kHz/24 bit	30 hours
FLAC 192 kHz/24 bit	26 hours
DSD 2.8224 MHz/1 bit	15 hours
DSD 5.6448 MHz/1 bit	13 hours
DSD 11.2896 MHz/1 bit	11 hours

Bluetooth (Approx.)

MP3 128 kbps	SBC - Connection Preferred: 17 hours
FLAC 96 kHz/24 bit	LDAC - Connection Preferred (Auto): 15 hours

Note

- Even if the player is turned off for an extended period, a small amount of battery power is still consumed.
- Battery life may vary depending on volume setting, conditions of use and ambient temperature.
- The battery is consumed considerably when the screen is on.
- The battery life may become about 45 % shorter when some of the sound quality settings are active.
- A Bluetooth connection will shorten the battery life by up to 55 % depending on the following conditions.
 - Format of the content.
 - Settings of the connected device.

Digital Music Player
NW-WM1A/WM1Z

Maximum recordable number of songs

The approximate times are based on the case in which you transfer or record only 4 minute songs.

Number (Approx.)

	NW-WM1Z (256 GB)	NW-WM1A (128 GB)
MP3 128 kbps	20,000 songs	20,000 songs
AAC 256 kbps	20,000 songs	15,000 songs
FLAC 44.1 kHz/16 bit	5,700 songs	2,800 songs
FLAC 96 kHz/24bit	1,700 songs	860 songs
FLAC 192 kHz/24 bit	870 songs	430 songs
DSD 2.8224 MHz/1 bit	1,400 songs	700 songs
DSD 5.6448 MHz/1 bit	710 songs	350 songs
DSD 11.2896 MHz/1 bit	350 songs	170 songs

The contents of the Help Guide may be subject to change without notice due to updates to the product's specifications.

Digital Music Player
NW-WM1A/WM1Z

Supported formats

Music (*1, *2, *3)

Audio Formats

MP3

Media File format: MP3 (MPEG-1 Layer3) file format
File extension: .mp3
Bit rate: 32 kbps to 320 kbps (Supports variable bit rate (VBR))
Sampling frequency: 32, 44.1, 48 kHz

WMA

Media File format: ASF file format
File extension: .wma
Bit rate: 32 kbps to 192 kbps (Supports variable bit rate (VBR))
Sampling frequency: 44.1 kHz

FLAC

Media File format: FLAC file format
File extension: .flac
Bit depth: 16, 24 bit
Sampling frequency: 8, 11.025, 12, 16, 22.05, 24, 32, 44.1, 48, 88.2, 96, 176.4, 192, 352.8, 384 kHz

Linear PCM

Media File format: Wave-Riff file format
File extension: .wav
Bit depth: 16, 24, 32 bit (float/integer)
Sampling frequency: 8, 11.025, 12, 16, 22.05, 24, 32, 44.1, 48, 88.2, 96, 176.4, 192, 352.8, 384 kHz

AAC

Media File format: MP4 file format
File extension: .mp4, .m4a, .3gp
Bit rate: 16 kbps to 320 kbps (Supports variable bit rate (VBR))
Sampling frequency: 8, 11.025, 12, 16, 22.05, 24, 32, 44.1, 48 kHz

HE-AAC

Media File format: MP4 file format
File extension: .mp4, .m4a, .3gp
Bit rate: 32 kbps to 144 kbps

Sampling frequency: 8, 11.025, 12, 16, 22.05, 24, 32, 44.1, 48 kHz

Apple Lossless

Media File format: MP4 file format

File extension: .m4a, .mp4

Bit depth: 16, 24 bit

Sampling frequency: 8, 11.025, 12, 16, 22.05, 24, 32, 44.1, 48, 88.2, 96, 176.4, 192, 352.8, 384 kHz

AIFF

Media File format: AIFF file format

File extension: .aif, .aiff, .afc, .aifc

Bit depth: 16, 24, 32 bit

Sampling frequency: 8, 11.025, 12, 16, 22.05, 24, 32, 44.1, 48, 88.2, 96, 176.4, 192, 352.8, 384 kHz

DSD

Media File format: DSF, DSDIFF

File extension: .dsf, .dff

Bit depth: 1 bit

Sampling frequency: 2.8224, 5.6448, 11.2896 MHz

Note

- Files that are 4 GB or larger cannot be played back.
- This product recognizes audio sources exceeding CD quality (44.1 kHz/16 bit quantization) and DAT quality (48 kHz/16 bit quantization) as High-Resolution Audio.
- The “HR” symbol is displayed for High-Resolution Audio sources.

*1 Sampling frequency may not correspond to all encoders.

*2 Copyright protected files cannot be played back.

*3 Non-standard bit rates or non-guaranteed bit rates are included depending on the Sampling frequency.

The contents of the Help Guide may be subject to change without notice due to updates to the product's specifications.

Digital Music Player
NW-WM1A/WM1Z

System requirements

Computer

- Windows Vista® (Service Pack 2 or later)
- Windows® 7 (Service Pack 1 or later)
- Windows® 8.1
- Windows® 10
- Mac OS® X v10.8~10.11

Pre-installed OS only supported.
[Compatibility mode] is not supported.

PC application for Windows

Media Go application for Windows (recommendation)

- Internet connection
- Hard Disk Drive/Solid State Drive: 400 MB or more of available space

PC application for Mac

Content Transfer for Mac application for Mac (recommendation)

- Internet connection
- Hard Disk Drive/Solid State Drive: 30 MB or more of available space

Web browser

OS standard browser

Internet

Internet connection (for Gracenote® MusicID® service, podcast features, Store access, or online help)

Guarantee operation

Not supported by the following environments:

- Personally constructed computers or operating systems
- An environment that is an upgrade of the original manufacturer-installed operating system
- Multi-boot environment

We do not guarantee operation for all computers even if they meet the above System Requirements.

The contents of the Help Guide may be subject to change without notice due to updates to the product's specifications.

4-593-855-11(1) Copyright 2016 Sony Corporation

Digital Music Player
NW-WM1A/WM1Z

The built-in rechargeable battery becomes depleted quickly even after the Walkman is fully charged.

Limit the battery consumption to check if the battery condition improves. If the battery life becomes half as short as normal, consider replacing the battery.

The battery life depends on the conditions of use, settings, and ambient temperature. Furthermore, the following operations will deplete the battery more quickly than continuous use of the Walkman.

- Turning the Walkman on or off frequently.
- Changing the Walkman settings frequently.
- Charging and discharging the battery repeatedly.

This will gradually decrease the capacity of the battery. As a result, the battery may become depleted quickly even after it is fully charged.

To replace the battery, contact the nearest Sony dealer or Sony Service Center.

The contents of the Help Guide may be subject to change without notice due to updates to the product's specifications.

Digital Music Player
NW-WM1A/WM1Z

What is the battery lifespan?

The built-in rechargeable battery can be charged approximately 500 times.

The battery can be charged approximately 500 times on average.

However, the battery lifespan depends on the temperature and usage environment.

When the life of a fully charged battery becomes half as short as normal, consider replacing the battery.

To replace the battery, contact the nearest Sony dealer or Sony Service Center.

Do not replace the battery yourself. The battery is built into the Walkman. Battery replacement requires professional knowledge and skills.

The contents of the Help Guide may be subject to change without notice due to updates to the product's specifications.

Digital Music Player
NW-WM1A/WM1Z

Can I replace the built-in rechargeable battery myself?

Do not replace the battery yourself.

The battery is built into the Walkman. Battery replacement requires professional knowledge and skills. Do not replace the battery yourself.

The Walkman uses a designated rechargeable battery. Commercially available batteries cannot be used. To replace the battery, contact the nearest Sony dealer or Sony Service Center.

For your information

The battery performance deteriorates due to the following factors.

- The number of times you charge or discharge the battery.
- How long the battery is used.
- Usage environment.

The battery life can be an indicator for replacement.

When the life of a fully charged battery becomes half as short as normal, the battery should be replaced.

The battery can be charged approximately 500 times on average.

The contents of the Help Guide may be subject to change without notice due to updates to the product's specifications.

Digital Music Player
NW-WM1A/WM1Z

The computer does not recognize the microSD card in the Walkman.

Disconnect the Walkman from the computer, and then try the following measures. Insert the microSD card into the Walkman before you reconnect the Walkman to the computer. Then, check if the computer recognizes the microSD card.

- **The computer will not recognize the microSD card if the microSD card is not inserted correctly.**
If you can select [Mount/Unmount SD Card] on the Walkman, select it.
Then, remove the microSD card from the Walkman, and reinsert it securely.
To select [Mount/Unmount SD Card], tap the menu items in the following order.
 – [Settings] – [Device Settings] ([Basic Settings]) – [Mount/Unmount SD Card].
- **The computer may not recognize the microSD card if the microSD card is inserted after you connect the Walkman to the computer.**
Insert the microSD card into the Walkman before you connect the Walkman to the computer.

The contents of the Help Guide may be subject to change without notice due to updates to the product's specifications.

Digital Music Player
NW-WM1A/WM1Z

The Walkman does not recognize a microSD card.

Try the following measures.

- **The microSD card may not be inserted correctly.**
Remove the microSD card from the Walkman. Then, reinsert the microSD card securely.
- **The contact pins of the microSD card may be dirty.**
Clean the contact pins of the microSD card with a dry cloth or a cotton bud. Then, reinsert the microSD card.
- **The format of the microSD card is not supported by the Walkman.**
Copy all the data on the microSD card onto a computer first. Then, reformat the microSD card on the Walkman. Use the Walkman to reformat the microSD card. Sony does not guarantee the operation of microSD cards that have been reformatted on other devices such as computers.

The contents of the Help Guide may be subject to change without notice due to updates to the product's specifications.

Digital Music Player
NW-WM1A/WM1Z

Media Go cannot be installed on a computer. Installation of Media Go fails.

Make sure that the computer supports the system requirements for Media Go. Then, follow the procedures below to install Media Go.

Refer to the following website for the system requirements for Media Go.

<http://mediago.sony.com/>

1. Check the file size of the installer.

If the size of the downloaded Media Go installer is smaller than the size indicated in the download dialog, the installer may be damaged.

You cannot install Media Go properly with the damaged installer.

Download the installer again and try installing Media Go.

Media Go download website:

<http://mediago.sony.com/>

2. Stop background programs and check if the installation can be completed properly.

When background programs are active, the installation of Media Go may fail (background programs: security software, etc.).

Active programs may interfere with the installation of Media Go.

Stop all software including programs that are active in the background. Then, check if the installation succeeds.

3. Create a new account and check if the installation can be completed.

The current user account on the computer may not be capable of installing Media Go for some reason.

Create a new administrator account. Then, check if the installation succeeds.

The contents of the Help Guide may be subject to change without notice due to updates to the product's specifications.

Digital Music Player
NW-WM1A/WM1Z

Media Go does not recognize the Walkman.

Try the following series of operations and check if Media Go recognizes the Walkman.

- Disconnect the Walkman from the computer and restart the computer.
- Restart the Walkman. Then, reconnect the Walkman to the computer.
- Delete the device profile.

Follow the procedures below.

1. Disconnect the Walkman from the computer safely.

Before you disconnect the Walkman from the computer, click on [Safely Remove Hardware] in the notification area of the Desktop. Confirm that the Walkman can be disconnected safely before you disconnect it.

2. Check the battery level. Then, restart the Walkman.

The Walkman should be charged sufficiently before you restart it.

Hold down the  (power) button for 8 seconds until the Walkman restarts.

3. Restart the computer.

Make sure that the Walkman is disconnected at this time.

4. Connect the Walkman to the computer.

Use a different USB port from the one that did not recognize the Walkman. Check if the Walkman is recognized.

Note on the USB 3.0 port

If the Walkman is not recognized by the USB 3.0 port, try another USB port.

USB 3.0 ports have five terminals on the plastic part inside the connector. The plastic part of most manufacturers' USB 3.0 ports is blue.

5. If the computer still does not recognize the Walkman, try connecting a USB device other than the Walkman. Then, check if the USB port works properly.

Connect a USB device such as a mouse or keyboard to the computer and check if the device works properly.

If a USB device other than the Walkman does not work, the USB port on the computer may not be working. Contact the manufacturer of the computer to check the USB port.

6. Delete the device profile for the Walkman. Then, check if the computer recognizes the Walkman.

You can delete the device profile for the Walkman as follows.

From the Media Go menu at the top, select [Tools], [Preferences], and then [Devices].

Select the Walkman that Media Go does not recognize. Then, select [Delete Profile].

When the confirmation dialog appears, select [Yes].

The procedure is complete.

Reconnect the Walkman to the computer and check if the Walkman is recognized.

The contents of the Help Guide may be subject to change without notice due to updates to the product's specifications.

4-593-855-11(1) Copyright 2016 Sony Corporation

Digital Music Player
NW-WM1A/WM1Z

The Walkman cannot play transferred content.

Try the following measures.

[Cannot play; file format is not supported.] appears on the screen.

The Walkman only plays content in compatible formats.

For details on supported formats, refer to the specifications section of the [Help Guide] or the model website.

Make sure that the Walkman supports the format of the content you are trying to play.

When you cannot find the transferred content on the Walkman.

- Content may be transferred to folders or locations that the Walkman cannot access. This may happen when you drag-and-drop the content using Windows Explorer or Mac Finder. Transfer the content to the appropriate folder or location.
- When you transfer audio content in the MP4 format, drag-and-drop the content into the [MUSIC] folder on the Walkman.
- If you have performed one of the following operations on a computer, the content may not be recognized on the Walkman. In this case, change the file name or file location back to the original name or location.
 - You changed the file name of content on the Walkman.
 - You changed the location of content on the Walkman.
- If you formatted the memory of the Walkman in Windows Explorer or Mac Finder, reformat the memory using the menu on the Walkman.

The contents of the Help Guide may be subject to change without notice due to updates to the product's specifications.

Digital Music Player
NW-WM1A/WM1Z

A track is duplicated on the Walkman.

A track may be duplicated on the Walkman if you transfer the same track using different transfer methods.

A track may be duplicated for the following reasons.

- The same track is transferred repeatedly in different formats.
- The same track is transferred repeatedly with different track information.
- The same track is transferred repeatedly with different transfer methods (the same track is transferred to different storage folders).

You can delete unnecessary tracks from the Walkman.

The deletion method depends on how the track was transferred to the Walkman.

Why a track may be duplicated

The storage folder for tracks depends on the application used to transfer the tracks to the Walkman.

In the case of Media Go, tracks are transferred to the [MUSIC] folder. The tracks in the [MUSIC] folder may not be displayed in other music management applications.

Therefore, even if a track appears duplicated on the Walkman, the track will not appear duplicated in music management applications.

If you manage tracks with multiple applications, be careful to avoid duplicating tracks when you transfer them.

Note on using microSD cards

If the same track is transferred to both the Walkman and the microSD card, the track will be duplicated on the Walkman. Check the tracks on the Walkman and the microSD card to confirm that there are no duplicate tracks.

How to delete tracks from the Walkman

To delete tracks on the Walkman

1. On the library screen, tap the desired category (albums, artists, etc.), the desired subcategory, and then the desired track.
2. Tap  and then [Delete] to delete the track.

To delete tracks using Media Go

1. Connect the Walkman to the computer. Then, launch Media Go.
2. Double-click the model name of the Walkman in the left pane.
The device menu will appear.
3. Click [MUSIC].

Select the track that you want to delete. Select [Edit], and then [Delete] from the menu at the top.

- 4.
5. If a confirmation dialog appears, click [Yes] to delete the track.

To delete tracks using Windows Explorer

1. Connect the Walkman to the computer.
2. Open Windows Explorer. Then, open the folder for the Walkman that is connected to the computer.
3. Select the duplicate track in the [MUSIC] folder and delete the track.
Note that the track may be stored in a folder other than the [MUSIC] folder depending on the application that was used to transfer the track.

Hint

- Disable the automatic track transfer functions in music management applications such as the [Sync] function in Windows Media Player. If the function is enabled, tracks may be transferred to the [MUSIC] folder on the Walkman every time you connect the Walkman to the computer.
- When you transfer playlists to the Walkman using Media Go or Content Transfer for Mac, not only the playlist information but also track data may be transferred to the Walkman. If the track is not yet stored in the memory of the Walkman, the track will be transferred automatically along with the playlist information. Example: You transfer a playlist that includes "Track A" to the internal memory of the Walkman. "Track A" will be transferred to the Walkman memory even if "Track A" is already stored on the microSD card. This will result in duplication of "Track A" on the Walkman.

The contents of the Help Guide may be subject to change without notice due to updates to the product's specifications.

Digital Music Player
NW-WM1A/WM1Z

**You have spilled liquid (water, coffee, etc.) on the Walkman.
You have washed the Walkman in a washing machine.**

Contact the nearest Sony dealer or Sony Service Center.

Liquid may get inside the Walkman in the situations listed above.
Stop using the Walkman immediately. Then, contact the nearest Sony dealer or Sony Service Center.

The contents of the Help Guide may be subject to change without notice due to updates to the product's specifications.

Digital Music Player
NW-WM1A/WM1Z

The Walkman does not work properly.

If one of the following situations occurs, restart the Walkman.

- The Walkman does not respond to operations.
- The Walkman screen freezes.

Adequately charge the Walkman. Then, hold down the  (power) button for 8 seconds until the Walkman restarts.

The contents of the Help Guide may be subject to change without notice due to updates to the product's specifications.